

Layer 3 Gigabit Ethernet Switch

24+2G - WGS3-2620

4G+4slot – WGS3-404

User's Manual

Trademarks

Copyright (c) PLANET Technology Corp. 2002.

PLANET is a registered trademark of PLANET Technology Corp. All other trademarks belong to their respective owners.

Contents subject to revision without prior notice.

Disclaimer

Information furnished is believed to be accurate and reliable. However, no responsibility is assumed by for its use, nor for any infringements of patents or other rights of third parties, which may result from its use. No license is granted by implication or otherwise under any patent or patent rights. Right reserved to change specifications at any time without notice.

The publisher assumes no responsibility for errors that may appear in this document, nor does it make any commitment to update information it contains.

All brands and product names mentioned are trademarks or registered trademarks of their respective companies.

Caution: Do not use a RJ-11 (telephone) cable to connect your network equipment.

Important Safety Instructions

- Read all of these instructions.
- Save these instructions for later use.
- Follow all warnings and instructions marked on the product.
- Unplug this product from the wall outlet before cleaning. Do not use liquid cleaners or aerosol cleaners. Use a damp cloth for cleaning.
- Do not use this product near water.
- Do not place this product on an unstable cart or stand. The product may fall, causing serious damage to the product.
- The air vent should never be blocked by placing the product on a bed, sofa, rug, or other similar surface. This product should never be placed near or over a radiator or heat register. This product should not be placed in a built-in installation unless proper ventilation is provided.
- This product should be operated from the type of power source indicated on the marking label. If you are not sure of the type of power available, consult your dealer or local power company.
- This product is equipped with a three-wire grounding type plug, a plug having a third (grounding) pin. This plug will only fit into a grounding type power outlet. This is a safety feature. If you are unable to insert the plug into the outlet, contact your electrician to replace your outlet. Do not defeat the purpose of the grounding type plug.
- Do not allow anything to rest on the power cord. Do not place this product where persons will walk on the cord.
- If an extension cord is used with this product, make sure that the total ampere ratings on the products into the extension cord do not exceed the extension cord ampere rating. Also make sure that the total of all products plugged into the wall outlet does not exceed 15 amperes.
- Never push objects of any kind into this product through air ventilation slots as they may touch dangerous voltage points or short out parts that could result in a risk of fire or electric shock. Never spill liquid of any kind on the product.
- Do not attempt to service this product yourself, as opening or removing covers may expose you to dangerous voltage points or other risks. Refer all servicing to service personnel.
- Warnings

- Wear an anti-static wrist strap or take other suitable measures to prevent electrostatic discharge whenever handling this equipment.
- When connecting to a power outlet, connect the field ground lead on the triple power plug to a valid earth ground line to prevent electrical hazards.

FCC Compliance Statement

This equipment generates and uses radio frequency energy and if not installed and used properly, that is, in strict accordance with the instructions provided with the equipment, may cause interference to radio and TV communication. The equipment has been tested and found to comply with the limits for a Class A computing device in accordance with the specifications in Subpart B of Part 15 of FCC rules, which are designed to provide reasonable protection against such interference in a residential installation. However, there is no guarantee that interference will not occur in a particular installation. If you suspect this equipment is causing interference, turn your Ethernet Switch on and off while your radio or TV is showing interference, if the interference disappears when you turn your Ethernet Switch off and reappears when you turn it back on, there is interference being caused by the Ethernet Switch.

You can try to correct the interference by one or more of the following measures:

- ◆ Reorient the receiving radio or TV antenna where this may be done safely.
- ◆ To the extent possible, relocate the radio, TV or other receiver away from the Switch.
- ◆ Plug the Ethernet Switch into a different power outlet so that the Switch and the receiver are on different branch circuits.

If necessary, you should consult the place of purchase or an experienced radio/television technician for additional suggestions.

CE Mark Warning

In a domestic environment, this product may cause radio interference, in which case the user may be required to take adequate measures.

Revision

User's Manual for PLANET Layer 3 Gigabit Ethernet Switch

Model: WGS3-404, WGS3-2620

Rev: 2.0 (October, 2002)

Part No. EMQ-WGS3-v1

TABLE OF CONTENTS

CHAPTER 1. INTRODUCTION.....	1
1.1 FEATURES.....	1
1.2 SPECIFICATION.....	2
CHAPTER 2. INSTALLING THE SWITCH	4
2.1 PACKAGE CONTENTS.....	4
2.2 DESCRIPTION OF HARDWARE.....	4
2.2.1 <i>Front Panel of WGS3-2620</i>	4
2.2.1.1 Front Panel Description.....	4
2.2.1.2 Port Description.....	4
2.2.1.3 LED Definition.....	5
2.2.2 <i>Front Panel of WGS3-404</i>	5
2.2.2.1 Front Panel Description.....	5
2.2.2.2 Port Description.....	6
2.2.2.3 LED Definition.....	6
2.2.3 <i>Rear Panel of WGS3-2620 and WGS3-404</i>	6
2.2.4 <i>Module Hardware Description</i>	7
2.2.4.1 Panel Description.....	7
2.2.4.2 WGSW-C1GT LED Definition.....	7
2.2.4.3 WGSW-C1SX LED Definition.....	8
2.3 MOUNTING THE SWITCH.....	8
2.3.1 <i>Mounting Switches in a Rack</i>	8
2.4 CONNECTING THE SWITCH SYSTEM.....	8
2.4.1 <i>Making a Connection to an RJ-45 Port</i>	9
2.4.2 <i>Making a Connection to an Gigabit Fiber Module</i>	9
2.5 POWERING ON THE SWITCH.....	9
2.6 VERIFYING SYSTEM OPERATION.....	10
CHAPTER 3. SWITCH MANAGEMENT.....	11
3.1 CONFIGURATION OPTIONS.....	11
3.2 REQUIRED CONNECTIONS.....	11
3.2.1 <i>Console Port (Out-of-Band) Connections</i>	11
3.2.2 <i>In-Band Connections</i>	12
CHAPTER 4. CONSOLE INTERFACE.....	13
4.1 LOGIN SCREEN.....	13
4.2 MAIN MENU.....	15
4.3 SYSTEM INFORMATION MENU.....	17
4.3.1 <i>Displaying System Information</i>	18
4.3.2 <i>Displaying Switch Version Information</i>	19
4.3.2.1 Switch Information of WGS3-2620.....	19
4.3.2.2 Switch Information of WGS3-404.....	20
4.4 MANAGEMENT SETUP MENU.....	21
4.4.1 <i>Changing the Network Configuration</i>	22
4.4.1.1 IP Configuration (Layer 2 Mode).....	23
4.4.1.2 IP Connectivity Test (Ping).....	25
4.4.1.3 HTTP Configuration.....	26
4.4.2 <i>Configuring the Serial Port</i>	27
4.4.3 <i>Assigning SNMP Parameters</i>	29
4.4.3.1 Configuring Community Names.....	30
4.4.3.2 Configuring IP Trap Managers.....	31
4.4.4 <i>User Login Configuration</i>	32
4.4.5 <i>Downloading System Software</i>	34
4.4.6 <i>Saving or Restoring the System Configuration</i>	35
4.5 DEVICE CONTROL MENU.....	37
4.5.1 <i>Setting the System Operation Mode</i>	38
4.5.2 <i>Layer 2 Menu</i>	39
4.5.2.1 Configuring Port Parameters.....	40
4.5.2.2 Using a Mirror Port for Analysis.....	41

4.5.2.3 Configuring Port Trunks	42
4.5.2.4 Configuring the Static Unicast Address Table	44
4.5.2.5 Configuring the Static Multicast Address Table	45
4.5.3 Using the Bridge Menu	46
4.5.3.1 Configuring Global Bridge Settings	47
4.5.3.2 Configuring STA for Ports	50
4.5.4 Configuring Virtual LANs	52
4.5.4.1 VLAN Port Configuration	52
4.5.4.2 VLAN Table Configuration	55
4.5.4.3 Reset Address Table Mode	57
4.5.5 Configuring IGMP Snooping	58
4.5.6 Configuring IP Settings	60
4.5.6.1 Subnet Configuration	62
4.5.6.1.1 Adding an IP Interface	63
4.5.6.1.2 Configuring Port Groups	65
4.5.6.1.3 Modifying an IP Interface	66
4.5.6.1.4 Configuring RIP	67
4.5.6.1.5 Configuring OSPF	69
4.5.6.1.5 Configuring DVMRP	72
4.5.6.2 Protocol Configuration	73
4.5.6.2.1 Setting the ARP Timeout	75
4.5.6.2.2 Setting the RIP Advertisement Policy	76
4.5.6.2.3 Configuring Global Settings for OSPF	77
4.5.6.2.3.1 OSPF Area Configuration	79
4.5.6.2.3.2 OSPF Area Range Configuration	81
4.5.6.2.3.3 OSPF Virtual Link Configuration	82
4.5.6.2.4 Configuring DHCP Relay	84
4.5.6.3 Static ARP Configuration	85
4.5.6.4 Static Route Configuration	86
4.5.6.5 Configuring the Default Route	88
4.5.7 Security Menu	89
4.5.7.1 Configuring MAC Address Filters	90
4.5.7.2 IP Filtering Configuration	91
4.5.8 Jumbo Packet Configuration	92
4.6 MONITORING THE SWITCH	93
4.6.1 Displaying Port Statistics	94
4.6.1.1 Displaying Ethernet Port Statistics	95
4.6.1.2 Displaying RMON Statistics	97
4.6.2 Layer 2 Address Tables	99
4.6.2.1 Displaying the Unicast Address Table	100
4.6.3 Displaying Bridge Information	101
4.6.3.1 Viewing the Current Spanning Tree Bridge Information	102
4.6.3.2 Displaying the Current Spanning Tree Port information	104
4.6.4 Displaying VLAN Information	106
4.6.4.1 VLAN Dynamic Registration Information	107
4.6.4.2 VLAN Forwarding Information	108
4.6.5 IP Multicast Registration Table	109
4.6.6 IP Address Table	110
4.6.6.1 Displaying Subnet Information	111
4.6.6.2 ARP Table	112
4.6.6.3 Routing Table	113
4.6.6.3.1 Displaying Detailed Routing Information	115
4.6.6.4 Multicast Table	116
4.6.6.4.1 Displaying IGMP Registration Table	117
4.6.6.4.2 Displaying the Multicast Forwarding Cache	119
4.6.6.4.3 Displaying the DVMRP Routing Table	120
4.6.6.4.4 Displaying the DVMRP Neighbor Table	121
4.6.6.5 OSPF Table	122
4.6.6.5.1 Display Interface Table	123
4.6.6.5.2 Displaying the Link State Table	124
4.6.6.5.3 Displaying the Neighbor Table	126
4.6.6.5.4 Displaying the Virtual Neighbor Table	128
4.7 RESETTING THE SYSTEM	130
4.8 LOGGING OFF THE SYSTEM	131
CHAPTER 5. WEB INTERFACE	132
5.1 WEB-BASED CONFIGURATION AND MONITORING	132

5.2 NAVIGATING THE WEB BROWSER INTERFACE	134
5.2.1 Home Page	134
5.2.2 Configuration Options	136
5.3 PANEL DISPLAY	137
5.3.1 Port State Display	137
5.3.2 Configuring the Serial Port	139
5.4 MAIN MENU	140
5.5 SYSTEM INFORMATION MENU	142
5.5.1 Displaying System Information	142
5.5.2 Displaying Switch Version Information	143
5.5.2.1 WGS3-2620	143
5.5.2.2 WGS3-404	144
5.6 MANAGEMENT SETUP MENU	145
5.6.1 Changing the Network Configuration (Layer 2 Mode of WGS3-2620)	146
5.6.2 Assigning SNMP Parameters	149
5.6.2.1 Configuring Community Names	149
5.6.2.2 Configuring IP Trap Managers	150
5.6.3 User Login Configuration	151
5.6.3.1 Displaying the Current User Configuration	151
5.6.4 Downloading System Software	152
5.6.5 Saving or Restoring the System Configuration	153
5.7 DEVICE CONTROL MENU	154
5.7.1 Layer 2 Menu	155
5.7.1.1 Configuring Port Parameters	155
5.7.1.2 Using Port Mirror for Analysis	157
5.7.1.2.1 Using Port Mirroring on WGS3-2620	157
5.7.1.2.2 Using Port Mirroring on WGS3-404	158
5.7.1.3 Configuring Port Trunks	159
5.7.1.4 Static Unicast Address Table	161
5.7.1.5 Configuring the Static Multicast Address Table	162
5.7.2 Using the Bridge Menu	163
5.7.2.1 Configuring Global Bridge Settings	163
5.7.2.2 Configuring STA for Ports	166
5.7.3 Configuring Virtual LANs	168
5.7.3.1 VLAN Port Configuration	168
5.7.3.2 VLAN Table Configuration	171
5.7.3.3 Reset Address Table Mode	173
5.7.4 Configuring IGMP Snooping	174
5.7.5 Configuring IP Settings	176
5.7.5.1 Subnet Configuration	177
5.7.5.1.1 Adding an IP Interface	178
5.7.5.1.2 Modifying an IP Interface	178
5.7.5.1.3 Configuring RIP	178
5.7.5.1.4 Configuring OSPF	180
5.7.5.1.5 Configuring DVMRP	183
5.7.5.2 Protocol Configuration	184
5.7.5.2.1 Setting the ARP Timeout	186
5.7.5.2.2 Setting the RIP Advertisement Policy	186
5.7.5.2.3 Configuring Global Settings for OSPF	187
5.7.5.2.3.1 OSPF Area Configuration	189
5.7.5.2.3.2 OSPF Area Range Configuration	190
5.7.5.2.3.3 OSPF Virtual Link Configuration	191
5.7.5.2.4 Configuring BOOTP/DHCP Relay	193
5.7.5.3 Static ARP Configuration	195
5.7.5.4 Static Route Configuration	196
5.7.5.5 Configuring the Default Route	198
5.7.6 Configuring Security Filters	199
5.7.6.1 Configuring MAC Address Filters	199
5.7.6.2 Configuring IP Address Filters	199
5.7.7 Jumbo Packet Configuration	200
5.8 MONITORING THE SWITCH	201
5.8.1 Displaying Port Statistics	202
5.8.1.1 Displaying Ethernet Port Statistics	202
5.8.1.2 Displaying RMON Statistics	205
5.8.2 Layer 2 Address Tables	207
5.8.2.1 Displaying the Unicast Address Table	207

5.8.3 Displaying Bridge Information.....	208
5.8.3.1 Viewing the Current Spanning Tree Information.....	208
5.8.3.2 Displaying the Current STA for Ports.....	210
5.8.4 Displaying VLAN Information.....	212
5.8.4.1 VLAN Dynamic Registration Information	212
5.8.4.2 VLAN Forwarding Information	212
5.8.5 IP Multicast Registration Table	213
5.8.6 IP Menu.....	214
5.8.6.1 Displaying Subnet Information.....	214
5.8.6.2 ARP Table.....	215
5.8.6.3 Routing Table.....	215
5.8.6.4 Multicast Table	217
5.8.6.4.1 Displaying IGMP Registration Table.....	218
5.8.6.4.2 Displaying the Multicast Forwarding Cache	219
5.8.6.4.3 Displaying the DVMRP Routing Table.....	220
5.8.6.4.4 Displaying the DVMRP Neighbor Table	221
5.8.6.5 OSPF Table	222
5.8.6.5.1 Display Interface Table.....	222
5.8.6.5.2 Displaying the Link State Table.....	222
5.8.6.5.3 Displaying the Neighbor Table.....	223
5.8.6.5.4 Displaying the Virtual Neighbor Table	225
5.9 RESET THE SYSTEM.....	227
CHAPTER 6.ADVANCED TOPICS.....	228
6.1 LAYER 2 SWITCHING	228
6.1.1 Unicast Switching.....	229
6.1.2 Multicast Switching	230
6.1.3 Spanning Tree Algorithm	230
6.2 LAYER 3 SWITCHING	232
6.2.1 Initial Configuration	232
6.2.2 IP Switching	233
6.2.3 Routing Path Management.....	234
6.2.4 ICMP Router Discovery	234
6.2.5 Proxy ARP	234
6.2.6 Routing Protocols.....	235
6.2.6.1 RIP and RIP-2 Dynamic Routing Protocols	235
6.2.6.2 OSPFv2 Dynamic Routing Protocol.....	236
6.2.7 Non-IP Protocol Routing.....	238
6.3 VIRTUAL LANs	239
6.3.1 Assigning Ports to VLANs.....	240
6.3.1.1 VLAN Classification	240
6.3.1.2 Port Overlapping.....	240
6.3.1.3 Port-based VLANs.....	240
6.3.1.4 Automatic VLAN Registration (GVRP).....	240
6.3.2 Forwarding Tagged/Untagged Frames	241
6.3.3 Connecting VLAN Groups	242
6.4 MULTICAST FILTERING.....	243
6.4.1 IGMP Snooping.....	243
6.4.2 IGMP Protocol.....	243
6.4.3 GMRP Protocol.....	244
6.4.4 DVMRP Routing Protocol	244
6.5 CLASS-OF-SERVICE (CoS) SUPPORT	245
6.6 BOOTP/DHCP RELAY.....	246
6.7 SECURITY FEATURES.....	247
6.7.1 SNMP Community Strings.....	247
6.7.2 User Name and Passwords	247
6.7.3 MAC Address Filters.....	247
6.7.4 IP Address Filters.....	247
6.8 SNMP MANAGEMENT SOFTWARE	248
6.9 REMOTE MONITORING (RMON).....	248
APPENDIX A TROUBLESHOOTING.....	249
A.1 TROUBLESHOOTING CHART	249
A.2 UPGRADING FIRMWARE VIA THE SERIAL PORT	250

APPENDIX B PIN ASSIGNMENTS	252
CONSOLE PORT PIN ASSIGNMENTS	252
DB-9 PORT PIN ASSIGNMENTS	253
CONSOLE PORT TO 9-PIN COM PORT ON PC.....	253
CONSOLE PORT TO 25-PIN DCE PORT ON MODEM.....	255
GLOSSARY	256

Chapter 1. Introduction

Both WGS3-404 and WGS3-2620 are IP-based Layer 3 Gigabit Ethernet Switch. WGS3-404 is with 4-port 10/100/1000Mbps and 4-slot for 1000Base-T and 1000Base-SX modules. WGS3-2620 is with 24-port 10/100Mbps and 2-port 1000Mbps switches.

The 2 and four RJ-45 gigabit copper ports support 10/100/1000Mbps auto-MDI/MDI-X detection that can directly connect to any Gigabit Ethernet Servers, Switches, L3 backbone with a straight Category 5/5e, 8-wire UTP cable.

The wire-speed switch engine provides up to 8.53 and 16Gbps switch fabric for L2 and L3 IP routing capability. Up to 256 IP subnet / L2 tagged VLAN are also available to segment the IP or MAC-based networks. IEEE802.1D Spanning Tree, bridging, Port mirroring and port trunking also support for optimal LAN connection and diagnose. IGMP snooping, filtering, dual priority helps to build a multimedia networks like video-conference etc.

Designed to offer the guaranteed IP Layer 3 routing with RIP, OSPF and DVMRP support, the WGS3-404 and WGS3-2620 empower the performance of pure IP-based network easier then ever.

1.1 Features

- WGS3-404 is with 4-port 10/100/1000Mbps and 4-slot for 1000Base-SX, 1000Base-T modules.
- WGS3-2620 is with 2-port 1000Mbps, 24-port 10/100Mbps Ethernet Switch
- Complies with IEEE 802.3, 10Base-T, IEEE 802.3u, 100Base-TX, IEEE 802.3z, 1000Base-SX and IEEE 802.3ab, 1000Base-T standards
- IEEE 802.3x, full-duplex flow control compliant; back-pressure half-duplex flow control
- IEEE 802.1p, dual priority; IEEE802.1Q, VLAN Tagging; IEEE802.1D Bridging compliant
- 32K MAC address table auto-ageing / 64K IP address at most
- IPv4 Layer 3 routing, supporting RIP-1/2, OSPF, DVMRP (Distance-Vector Multicast Routing Protocol)
- 8.53G/19.2G non-blocking, Store and Forward switching architecture
- RS-232 console interface for console program managements, Web / Telnet Support
- Port-based Trunking support increase the bandwidth between switches (2/4/8-port in one trunk)
- 255 port-based VLANs eliminate the broadcast-packet, increase the LAN security for different segments
- IGMP multicast snooping and filtering
- Port mirroring for port traffic diagnose with sniffer programs
- RMON group 1, 2, 3, 9 support
- 19", 1U height rack mounting
- 100~240VAC, 50~60Hz universal Power input
- FCC, CE class A compliant

1.2 Specification

HARDWARE SPECIFICATIONS		
Product	IP Layer 3 10/100/1000Mbps Routing Switch	
Model	WGS3-2620	WGS3-404
100Base-TX Ports	24	
1000Base-T Ports	2	4
Module Slot		4
LED for system	Power, SNMP, Console, Fan	Power, OverHeat, FanFailure
LED indicators for 100Base-TX	Two per port; Link, Mode (Modes include FDX, ACT, Speed)	
LED indicators for 1000Base-T	LNK, FDX	10, 100, 1000, FDX/COL, ACT
Media Type	RJ-45 STP, Auto-MDI/MDI-X on Gigabit port	
Cabling	100Mbps: Category 5 UTP, 4-wire 1000Mbps: Category 5/5e or above, 8-wire	
Rack Mount	1.U, 19" Rack mount	
Dimensions	430 mm x 334 mm x 44 mm (W x D x H)	
Weight	4.2kg	4kg
SWITCHING SPECIFICATIONS		
Architecture	High Performance Store & Forward Switching Architecture	
Buffer Memory	4MB	6MB
Switching fabric	8.53Gbps	19.2Gbps
MAC address Table	Layer 2: 32K MAC-entry Layer 3:64K IP- entry	
Forwarding/filtering rate	Layer 2 wired speed forwarding Layer 3 wired speed forwarding	
Error Checking	Runt & CRC on all network packets	
Trunking	10/100 Ports: Up to 8 ports per trunk Gigabit Ports: 2 gigabit ports as a trunk	Up to 4 ports per trunk
Port Mirroring	Monitor port transmitting / receiving activity	
QoS	Port based, VLAN tag Dual priority queues for each port	4 priority queues for each port
Protocol Compatibility	Layer 2: Transparent to higher layer protocols Layer 3: IP RIP-1, RIP-2, OSPF DVMRP	
Security	IP and MAC filtering	
Configuration	telnet, Web, RS-232 DB-9 console port and SNMP	
Network Management	RFC 1157 SNMP v1/v2 RFC 1213 MIB II RFC 1493 Bridge MIB RFC 1643 Ethernet MIB RFC 1724 RIP v2 MIB RFC 1757 RMON 4 groups: stats, history, Alarms & Events	
Protocols and Standards	IEEE 802.3 Ethernet IEEE 802.3u Fast Ethernet IEEE 802.3z/802.3ab Gigabit Ethernet	

	IEEE 802.3x Flow Control IEEE 802.1p QoS priority IEEE 802.1Q VLAN tag IEEE 802.1D Spanning Tree Protocol RFC 768 UDP RFC 783 TFTP RFC 791 IP RFC 792 ICMP RFC 826 ARP RFC 854 Telnet RFC 1058 RIP RFC 1122 Host Requirements RFC 1256 ICMP Router Discover Protocol RFC 1519 CIDR RFC 1583 OSPF version 2 RFC 1723 RIP v2 RFC 1812 IP Router Requirement RFC 2068 HTTP RFC 2131 DHCP Relay RFC 2236 IGMPv2 DVMRP
<i>Environment Specification</i>	
Power Consumption	65 watts / 220 BTU
AC Power	100~240V AC, 50/60Hz auto-sensing
Temperature	0~40 degree C operating
Humidity	10~90% non-condensing
Emission	FCC Class A, CE mark

Chapter 2. Installing the Switch

Before installing the switch, verify that you have all the items listed under "Package Contents." Also be sure you have all the necessary tools and cabling before installing the switch. Note that this switch can be installed on any suitably large flat surface or in a standard EIA 19-inch rack. After installing the switch, refer to the following chapter to set up its more advanced features, such as Spanning Tree Protocol or VLAN port groups.

2.1 Package Contents

This package includes:

- WGS3-404 or WGS3-2620
- Quick Installation Guide
- Rack mount bracket kit
- AC power cord
- This Manual CD
- Console cable

2.2 Description of Hardware

2.2.1 Front Panel of WGS3-2620

The front panel of the Switch has 24 RJ-45 ports for 10/100 Mbps in the middle. The port status LEDs are indicated at the left. The 1000Base-T ports are situated at the right.

2.2.1.1 Front Panel Description

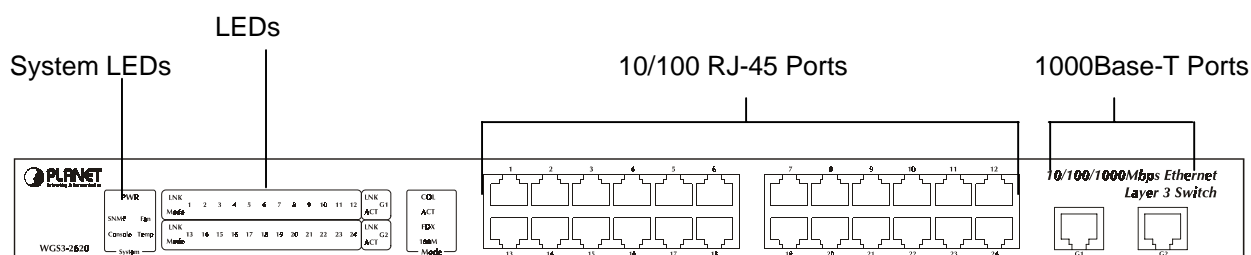

2.2.1.2 Port Description

Ports	# of Ports	Description
10/100	24	These RJ-45 ports support network speeds of either 10Mbps or 100 Mbps, and can operate in half- or full-duplex modes.
1000Base-T	2	These two RJ-45 ports provide 1000Base-T network connection and can operate on full-duplex modes.

2.2.1.3 LED Definition

The LEDs indicate the status of 10/100 Mbps Ethernet ports, 1000Base-T ports, Temp. Fan and Power.

LED	State	Indication
System		
Power	On	Switch is receiving power.
SNMP	On	SNMP agent operational.
Console	On	RS-232 Console interface is operating
Fan ^{*1}	On	One of the fans is failed and standby fan is running
Temp ^{*2}	On	The internal temperature is equal to or higher than 60 degree C
10BaseT/100BaseTX Ports		
LNK	On	Port has established a valid network connection
Mode ^{*3}		
COL	On	Collision occurs on the port
ACT	On	Traffic is passing through the port
FDX	On	Been set to full duplex
100M	On	Connected on 100M speed
1000BaseT Ports		
LNK	On	Port has established a valid network connection
ACT	On	Traffic is passing through the port
<p>*1 There are two 4-inch fans and one 2-inch fan in the unit. Normally, one of the 4-inch fans and 2-inch fan is running. Another 4-inch fan is standby and not working. Once one of the two running fans is failed, the standby fan will be drove to run and the Fan LED will light on.</p> <p>*2 When the internal temperature is equal to or higher than 60 degree C, the standby fan will be drove to run and the Temp LED will light on. Once the temperature is equal to or higher than 70 degree C, the buzzer will sound. You can press the buzzer On/Off button to turn off the buzzer.</p> <p>*3 Use the Mode button to select LED display mode.</p>		

2.2.2 Front Panel of WGS3-404

The front panel of the WGS3-404 has 4 RJ-45 ports for 10/100/1000 Mbps in the middle. The port status LEDs are indicated at the left. The expansion modules are situated at the right.

2.2.2.1 Front Panel Description

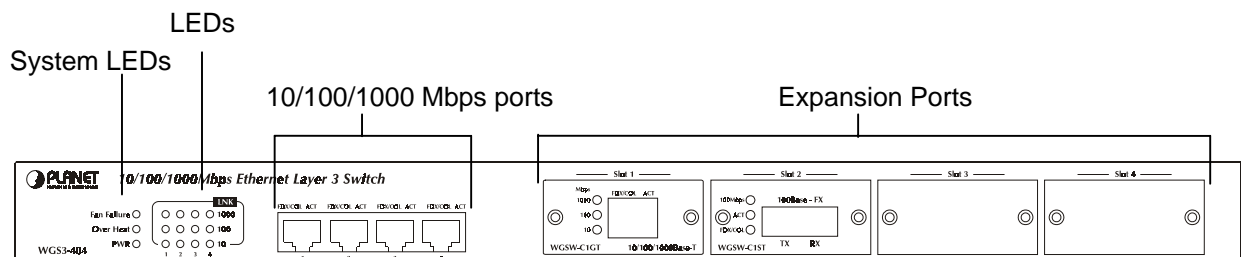

2.2.2.2 Port Description

Ports	# of Ports	Description
10/100/1000	4	These RJ-45 ports support network speeds of 10, 100 or 1000 Mbps, and can operate in full-duplex modes.
Expansion Ports	4	These ports provide for the installation of one or two expansion modules that establish a Fast or Gigabit Ethernet connection. Note: You may install an 1000Base-SX or 1000Base-T expansion module and use fiber optic or category 5 cabling.

2.2.2.3 LED Definition

The LEDs indicate the status of 10/100/1000 Mbps Ethernet ports, Over Heat, Fan Failure and Power. The LEDs are explained in the following tables.

LED	Color	Indication
System		
Power	Green	<i>Lights</i> to indicate switch is receiving power.
Fan Failure ^{*1}	Red	<i>Lights</i> to indicate one of the fans is failed and standby fan is running
Over Heat ^{*2}	Red	<i>Lights</i> to indicate the internal temperature is equal to or higher than 60 degree C
10/100/1000 Ports		
Act	Green	<i>Lights</i> to indicate the Switch is actively receiving or sending the data over the port.
FDX/COL	Yellow	<i>Lights</i> green to indicate that the port is operating in full-duplex mode. Blinks orange periodically to indicate that the connection is experiencing collisions.
1000	Green	<i>Lights</i> to indicate that the Switch is sending or receiving data at 1000 Mbps.
100	Green	<i>Lights</i> to indicate that the Switch is sending or receiving data at 100 Mbps.
10	Yellow	<i>Lights</i> to indicate that the Switch is sending or receiving data at 10 Mbps.
<p>^{*1} There are two 4-inch fans and one 2-inch fan in the unit. Normally, one of the 4-inch fans and 2-inch fan is running. Another 4-inch fan is standby and not working. Once one of the two running fans is failed, the standby fan will be drove to run and the Fan LED will light on.</p> <p>^{*2} When the internal temperature is equal to or higher than 60 degree C, the standby fan will be drove to run and the Temp LED will light on. Once the temperature is equal to or higher than 70 degree C, the buzzer will sound. You can press the buzzer On/Off button to turn off the buzzer.</p>		

2.2.3 Rear Panel of WGS3-2620 and WGS3-404

The rear panel of WGS3-2620 and WGS3-404 has a power connector, a Buzzer button and a console port. The following picture shows their rear panel.

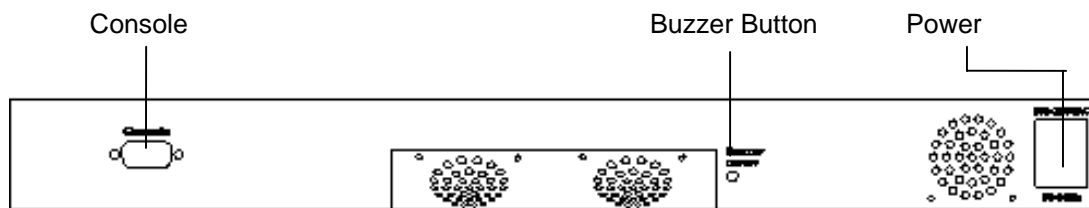

Port	Function
Power	This is where you will connect the AC power cord. 100~240VAC is allowed.
Console	This is where you will connect to the RS-232 serial port on your PC for configuring the management function, discussed in Chapter 3.

NOTE: To depress the **Buzzer button** will change the reaction of the buzzer. If the button is set to on, the buzzer will ring as the system is under the status of overheat. Set to off, the buzzer will not work even if the system overheats.

2.2.4 Module Hardware Description

WGS3-404 provides 4 slots for optional Gigabit copper and fiber module. The following picture show that front panel of gigabit expansion module.

2.2.4.1 Panel Description

WGSW-C1GT Module Status LEDs

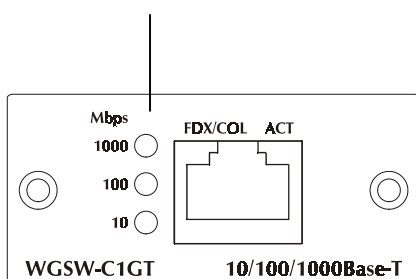

WGSW-C1SX Module Status LEDs

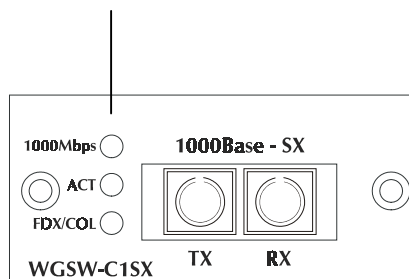

2.2.4.2 WGSW-C1GT LED Definition

LED	Color	Function
1000	Green	Lights to indicate that the Switch is sending or receiving data at 1000 Mbps.
100	Green	Lights to indicate that the Switch is sending or receiving data at 100 Mbps.
10	Yellow	Lights to indicate that the Switch is sending or receiving data at 10 Mbps.
FDX/COL	Yellow	Lights green to indicate that the port is operating in full-duplex mode. Blinks orange periodically to indicate that the connection is experiencing collisions.
Act	Green	Lights to indicate that the connection is acting.

2.2.4.3 WGSW-C1SX LED Definition

LED	Color	Function
1000	Green	<i>Lights</i> to indicate that receiver of fibre port is in normal optical input levels.
Act	Green	<i>Lights</i> to indicate that the connection is acting.
FDX/COL	Yellow	<i>Lights</i> to indicate that the port is operating at full duplex. This port does not support half duplex.

2.3 Mounting the Switch

The switch can be placed directly on your desktop, or mounted in a rack. Before you start installing the switch, make sure you can provide the right operating environment, including power requirements, sufficient physical space, and proximity to other network devices that are to be connected. Verify the following installation requirements:

- Power requirements: 100 to 240 V AC (+/-10%) at 50 to 60 Hz (+/-3Hz). The switch's power supply automatically adjusts to the input voltage level.
- The switch should be located in a cool dry place, with at least 10 cm. (4 in.) of space on the sides for ventilation.
- Place the switch out of direct sunlight, and away from heat sources or areas with a high amount of electromagnetic interference.
- If you intend to mount the switch in a rack, make sure you have all the necessary mounting screws, brackets, bolts and nuts, and the right tools.
- Check if network cables and connectors needed for installation are available.

2.3.1 Mounting Switches in a Rack

Please comply with the following instructions to ensure that your switch is securely mounted in the rack.

- Use a standard EIA 19-inch rack.
- Use the brackets and screws supplied in the rack mounting kit.
- Use a cross-head screwdriver to attach the brackets to the side of the switch.
- Position the switch in the rack by lining up the holes in the brackets with the appropriate holes on the rack, and then use the supplied screws to mount the switch in the rack.

2.4 Connecting the Switch System

The transmission speed for each port on the switch is automatically set by the switch to match the highest speed supported by the connected device. The transmission mode can be set for each port using auto-negotiation (if also supported by the attached device). However, if the device attached to any port on the switch does not support auto-negotiation, you can manually configure the transmission mode via the console port on the rear panel, or via an in-band connection (including Telnet, the Web agent).

2.4.1 Making a Connection to an RJ-45 Port

The Gigabit copper ports support Auto-MDI/MDI-X. You can use straight-through or crossover twisted-pair cable to connect any gigabit copper port on the switch to any device that uses a standard network interface such as a workstation or server, or to a network interconnection device such as a bridge or router.

Prepare the network devices you wish to network. Make sure you have installed 10BASE-T, 100BASE-TX or 1000BASE-T network interface cards for connecting to the switch's RJ-45 ports.

Prepare straight-through shielded or unshielded twisted-pair cables with RJ-45 plugs at both ends. Use 100-ohm Category 3, 4 or 5 cable for standard 10Mbps Ethernet connections, 100-ohm Category 5 cable for 100Mbps Fast Ethernet connections, or Category 5e cable for 1000Mbps Gigabit Ethernet connections.

Connect one end of the cable to the RJ-45 port of the network interface card, and the other end to any available RJ-45 port on the switch. When inserting an RJ-45 plug, be sure the tab on the plug clicks into position to ensure that it is properly seated. Using the switch in a stand-alone configuration, you can network up to 26 end nodes

NOTE: Make sure each twisted-pair cable does not exceed 100 meters (328 feet). We advise using Category 5e cable for all network connections to avoid any confusion or inconvenience in the future when you upgrade attached devices to Gigabit Ethernet.

Restrictions on Cascade Length - The IEEE 802.3 standard recommends restricting the number of hubs (i.e., repeaters) cascaded via twisted-pair cable to 4; while IEEE 802.3u provides even stricter recommendations for Fast Ethernet. Therefore, when cascading devices other than this switch, please refer to the accompanying documentation for cascade restrictions. However, note that because switches break up the path for connected devices into separate collision domains, you should not include the switch or connected cabling in your calculations for cascade length involving other devices.

2.4.2 Making a Connection to an Gigabit Fiber Module

The modules are fitted with SC connectors. Please be sure you run cable from the Rx (Tx) port on the module to the Tx (Rx) port on the target device. The length of Gigabit fiber optic cable for a single switched link should not exceed 220m for 62.5/125 multimode fiber and 500 m for 50/125 multimode fiber. However, power budget constraints must also be considered when calculating the maximum cable length for your specific environment.

2.5 Powering On the Switch

Plug the power cord into the power socket on the rear of the switch, and the other end into a power outlet.

Check the LED marked PWR on the front panel to see if it is on. The unit will automatically select the setting that matches the connected input voltage. Therefore, no additional adjustments are necessary when connecting it to any input voltage within the range marked on the rear panel.

The switch performs a self-diagnostic test upon power-on. (Note that this test takes about one minute to complete.)

NOTE: The unit supports a "hot remove" feature which permits you to connect or disconnect twisted-pair or fiber cables without powering off the switch and without disrupting the operation of the devices attached to the switch. However, due to the spanning tree learning process, the new attached device may takes about 30 seconds to be able to connect the other devices. This period can be shortened by adjusting the spanning tree configuration.

2.6 Verifying System Operation

Verify that all attached devices have a valid connection. The switch monitors the link status for each port. If any device is properly connected to the switch and transmitting a link beat signal, the Link indicator will light up for the corresponding port. If the Link indicator fails to light when you connect a device to the switch, check the following items:

Be sure all network cables and connectors are properly attached to the connected device and the switch.

See if your cable is functioning properly by using it for another port and attached device that displays valid indications when connected to the network.

Be sure no twisted-pair cable exceeds 100 meters (328 feet).

Chapter 3. Switch Management

3.1 Configuration Options

For advanced management capability, the on-board management agent provides a menu-driven system configuration program. This program can be accessed by serial port on the rear panel (out-of-band), or by a Telnet connection over the network (in-band).

The management agent is based on SNMP (Simple Network Management Protocol). This SNMP agent permits the switch to be managed from any PC in the network using in-band management software.

The management agent also includes an embedded HTTP Web agent. This Web agent can be accessed using Microsoft Internet Explorer 4.0 or later from any computer attached to the network.

The system configuration program and the SNMP agent support management functions such as:

- Enable/disable any port
- Set the communication mode for any port
- Configure SNMP parameters
- Add ports to network VLANs
- Configure IP routing and multicast VLANs
- Display system information or statistics
- Configure the switch to join a Spanning Tree
- Download system firmware

3.2 Required Connections

3.2.1 Console Port (Out-of-Band) Connections

Attach a VT100 compatible terminal or a PC running a terminal emulation program to the serial port on the switch's rear panel. Use the null-modem cable provided with this package, or use a null modem connection that complies with the wiring assignments shown in Appendix B of this manual.

When attaching to a PC, set terminal emulation type to VT100, specify the port used by your PC (i.e., COM 1~4), and then set communications to 8 data bits, 1 stop bit, no parity, and 19200 bps (for initial configuration). Also be sure to set flow control to "none." (Refer to "Configuring the Serial Port" for a complete description of configuration options.)

NOTE: If the default settings for the management agent's serial port have been modified and you are having difficulty making a console connection, you can display or modify the current settings using a Web browser as described under "Configuring the Serial Port".

3.2.2 In-Band Connections

Prior to accessing the switch's on-board agent via a network connection, you must first configure it with a valid IP address, subnet mask, and default gateway (for Layer 2 mode) using an out-of-band connection.

After configuring the switch's IP parameters, you can access the on-board configuration program from anywhere within the attached network. The on-board configuration program can be accessed using Telnet from any computer attached to the network. The switch can also be managed by any computer using a Web browser (Internet Explorer 4.0 or above, or Netscape Navigator 4.0 or above), or from a network computer using SNMP network management software.

Please note that:

- Each VLAN group can be assigned its own IP interface address. Therefore, if the port connected to the management station has joined several VLANs, you can manage the switch via any of these IP addresses.
- This switch supports four concurrent Telnet sessions.
- The on-board program only provides access to basic configuration functions. To access the full range of SNMP management functions, you must use SNMP-based network management software.

Chapter 4. Console Interface

4.1 Login Screen

Once a direct connection to the serial port or a Telnet connection is established, the login screen for the on-board configuration program appears as shown below.

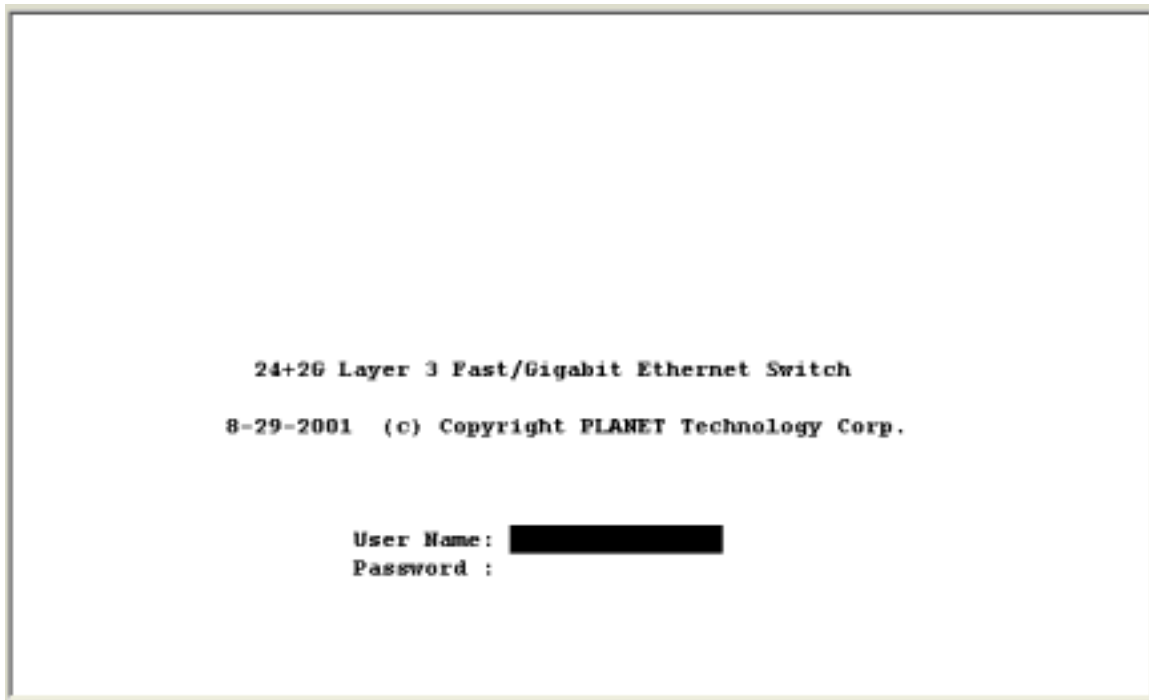

If this is your first time to log into the configuration program, then the default user names are “admin” with no password. The administrator has Read/Write access to all configuration parameters and statistics.

You should define a new administrator password, record it and put it in a safe place. Select User Configuration from the Management Setup Menu and enter a new password for the administrator. Note that passwords can consist of up to 15 alphanumeric characters and are not case sensitive.

NOTE: You are allowed three attempts to enter the correct password; on the third failed attempt the current connection is terminated.

After you enter the user name and password, you will have access to the system configuration program illustrated by the following menu map:

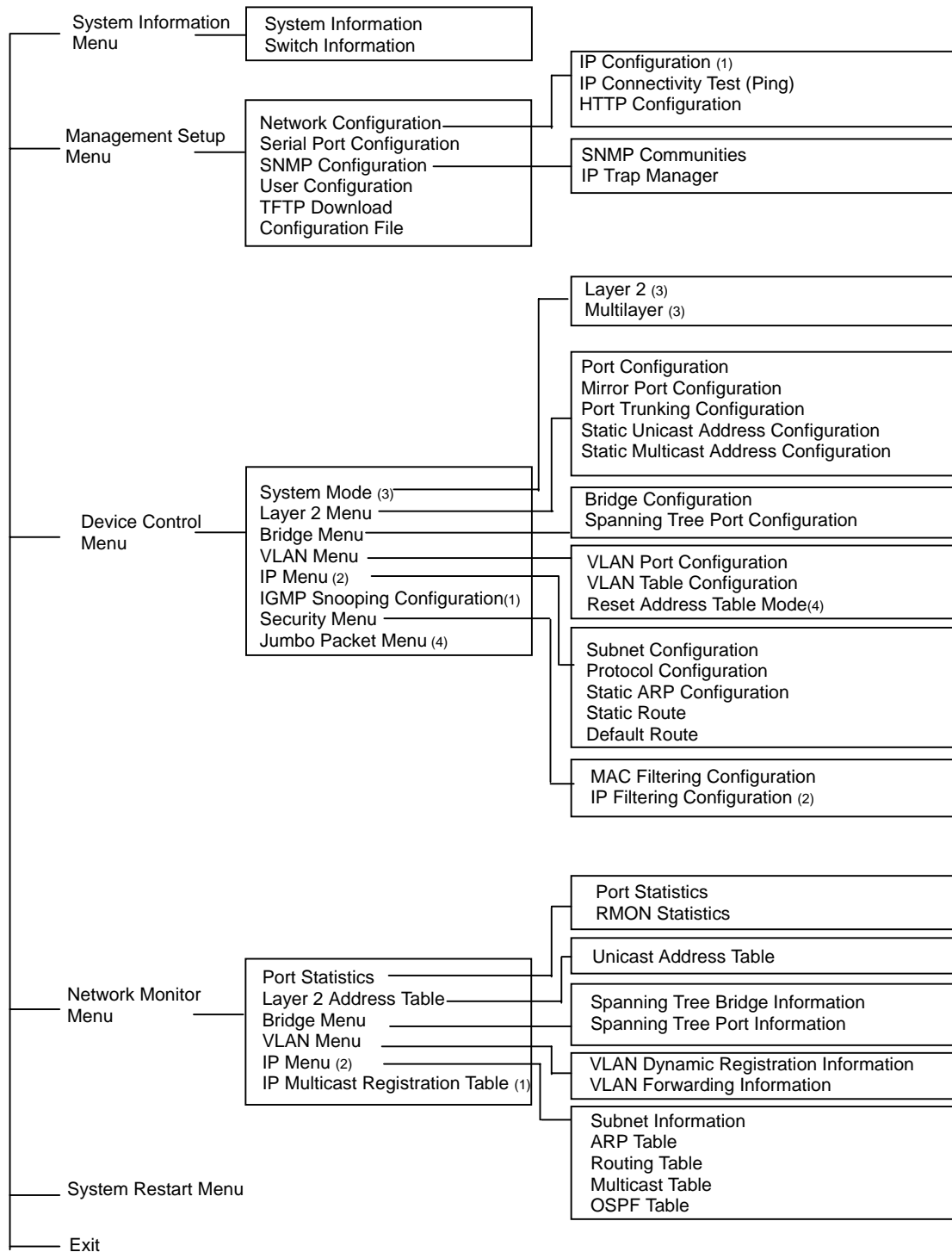

1. Displayed for layer 2 mode of WGS3-2620 only.
2. Displayed for multilayer mode of WGS3-2620 and WGS3-404 only
3. Displayed for WGS3-2620 only
4. Displayed for WGS3-404 only

4.2 Main Menu

With the system configuration program you can define system parameters, manage and control the switch and all its ports, or monitor network conditions. The figure below of the Main Menu and the following table briefly describe the selections available from this program.

NOTE: Options for the currently selected item are displayed in the highlighted area at the bottom of the interface screen.

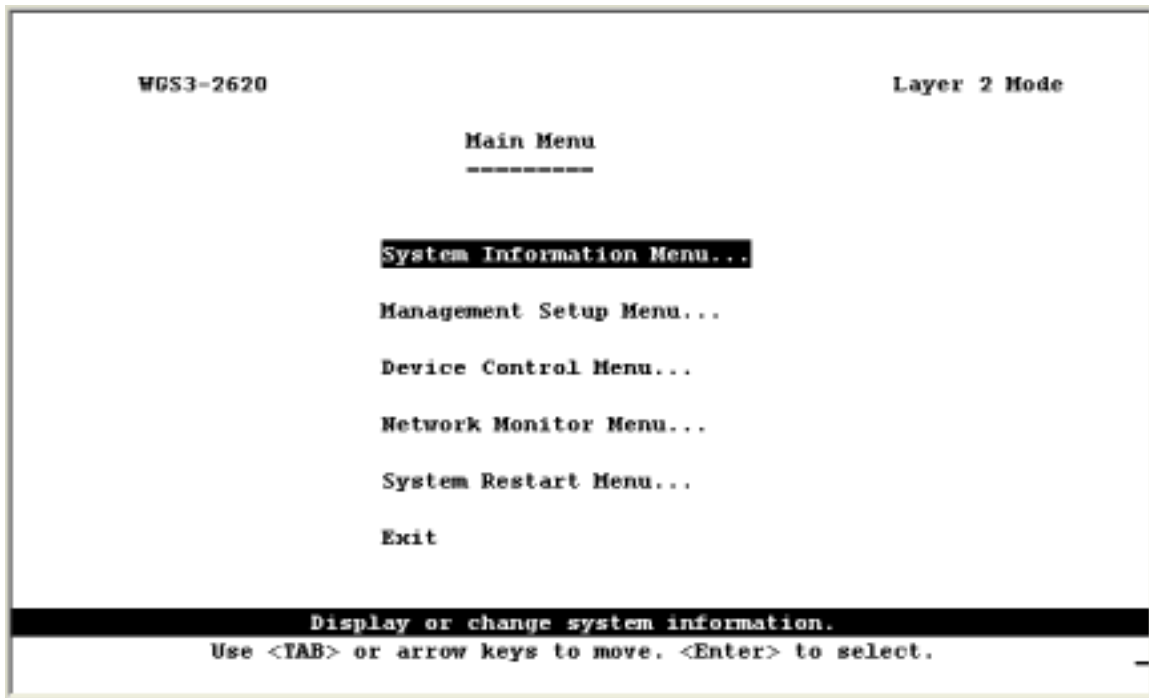

Menu	Description
(Operation Mode)	The text string in the top right corner of the screen shows if the switch is operating as a Layer 2 switch or as a multilayer routing switch. WGS3-404 is always operating as a multilayer routing switch and not showing this message.
<i>System Information Menu</i>	
System Information	Provides basic system description, including contact information.
Switch Information	Shows hardware/firmware version numbers, power status, and expansion modules used in the switch.
<i>Management Setup Menu</i>	
Network Configuration	Includes IP Configuration ^{*1} , Ping facility, and HTTP (Web agent) setup.
Serial Port Configuration	Sets communication parameters for the serial port, including baud rate, console time-out, and screen data refresh interval.
SNMP Configuration	Activates authentication failure traps; and configures community access strings, and trap managers.
User Configuration	Sets the user names and passwords for system access.

TFTP Download	Downloads new version of firmware to update your system (in-band).
Configuration File	Download the VLAN and routing configuration to a file or upload the configuration file to the switch.

Device Control Menu

System Mode ^{*3}	Sets the switch to operate as a Layer 2 switch or as a multilayer routing switch.
Layer 2 Menu	Configures port communication mode, mirror ports, port trunking and static unicast/multicast address.
Bridge Menu	Configures GMRP and GVRP for the bridge, and STA for the global bridge or for specific ports.
VLAN Menu	Configures VLAN settings for specific ports, and defines the port membership for VLAN groups.
IGMP Snooping Configuration ^{*1}	Configures IGMP multicast filtering.
IP Menu ^{*2}	Configures the subnets for each VLAN group, global configuration for unicast and multicast protocols, BOOPP/DHCP relay, static ARP table entries, static routes and the default route.
Security	Restrict access through MAC address or IP address ^{*2}
Jumbo Packet Menu ^{*4}	Allows the switch to send jumbo packet up to 9k

Network Monitor Menu

Port Statistics	Displays statistics on port traffic, including information from the Interfaces Group, Ethernet-link MIB, and RMON MIB.
Layer 2 Address Table	Contains tables for all unicast, static unicast, and static multicast addresses, as well as the filter table for MAC addresses.
Bridge Menu	Displays Spanning Tree Bridge and Port information
VLAN Menu	Displays dynamic port registration information for VLANs, as well as all VLAN forwarding information for static and dynamic assignment.
IP Multicast Registration Table ^{*1}	Displays all the multicast groups active on this switch, including the multicast IP addresses and corresponding VLANs.
IP Menu ^{*2}	Displays all the IP subnets used on this switch, as well as the corresponding VLANs and ports. Also contains the ARP table, routing table and multicast table.

System Restart Menu Restarts the system with options to reload factory defaults.

Exit Exits the configuration program.

*1: Only displays on WGS3-2620 when it is set to Layer 2 mode.

*2: Only displays on WGS3-404 and WGS3-2620 when it is set to multilayer mode.

*3: Only displays on WGS3-2620

*4: Only displays on WGS3-404

4.3 System Information Menu

Use the System Information Menu to display a basic description of the switch, including contact information, and hardware/firmware versions.



Menu	Description
System Information	Provides basic system description, including contact information.
Switch Information	Shows hardware/firmware version numbers, power status, and expansion modules used in the switch.

4.3.1 Displaying System Information

Use the System Information screen to display descriptive information about the switch, or for quick system identification as shown in the following figure and table.

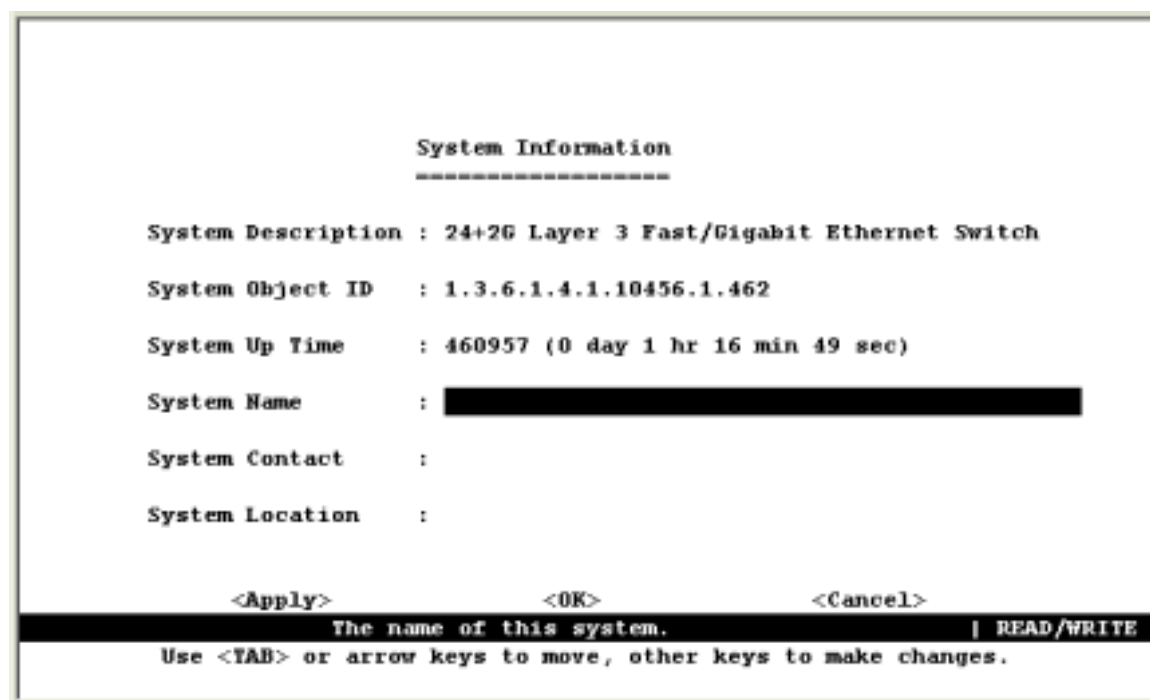

Parameter	Description
System Description	System hardware description.
System Object ID	MIB II object identifier for switch's network management subsystem.
System Up Time	Length of time the current management agent has been running. (Note that the first value is centiseconds.)
System Name*	Name assigned to the switch system.
System Contact*	Contact person for the system.
System Location*	Specifies the area or location where the system resides.

* Maximum string length is 99, but the screen only displays 45 characters. You can use the arrow keys to browse the whole string.

4.3.2 Displaying Switch Version Information

Use the Switch Information screen to display hardware/firmware version numbers for the main board, as well as the fan power status.

4.3.2.1 Switch Information of WGS3-2620



Parameter	Description
Hardware Version	Hardware version of the main board.
Firmware Version	System firmware version in ROM.
Serial Number	The serial number (MAC address) of the main board.
Port Number	Number of ports on this switch.
Power Status	Shows if power is active
Fan Power Status	Shows if power to the fan is active or inactive.
G1 and G2 Information	Shows the G1 and G2 connection type. It is always 1000Base-T on this version

4.3.2.2 Switch Information of WGS3-404



Parameter	Description
Hardware Version	Hardware version of the main board.
Firmware Version	System firmware version in ROM.
Serial Number	The serial number (MAC address) of the main board.
Port Number	Number of ports on this switch.
Packet Memory Size	Shows memory size for packet buffer. It is always 6M bytes.

4.4 Management Setup Menu

After initially logging onto the system, adjust the communication parameters for your console to ensure a reliable connection (Serial Port Configuration). Specify the IP addresses for the switch (Network Configuration / IP Configuration), and then set the Administrator and User passwords (User Configuration). Remember to record them in a safe place. Also set the community string which controls access to the on-board SNMP agent via in-band management software (SNMP Configuration). The items provided by the Management Setup Menu are described in the following sections.

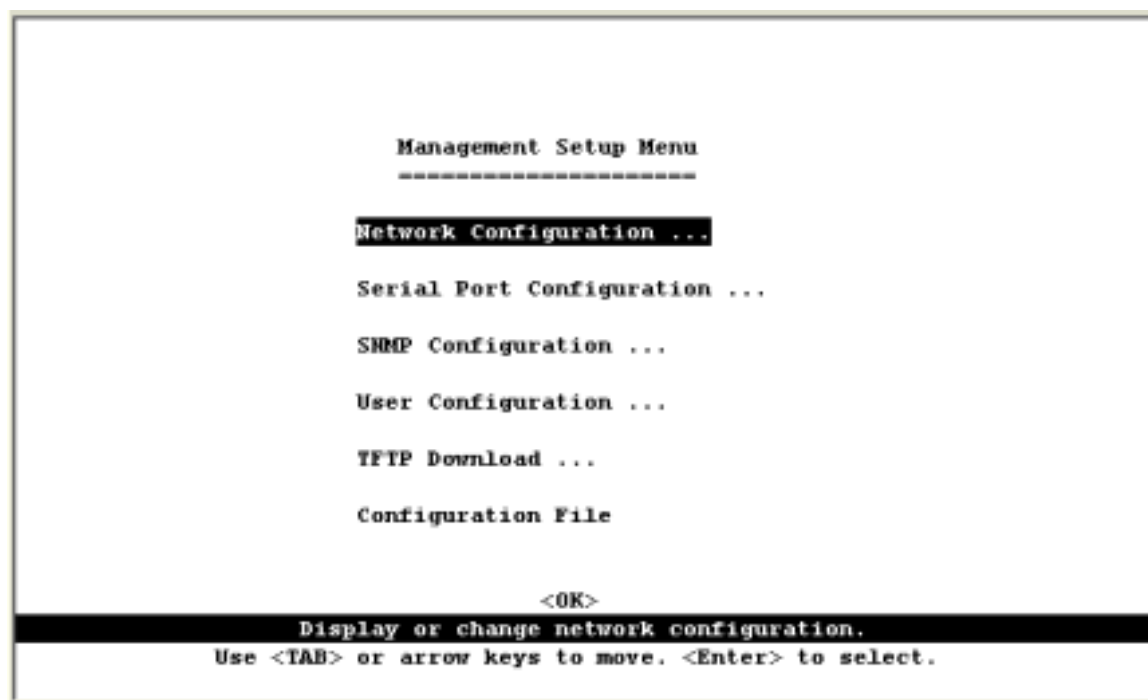

Menu	Description
Network Configuration	Includes IP Configuration ^{*1} , Ping facility, and HTTP (Web agent) setup.
Serial Port Configuration	Sets communication parameters for the serial port, including baud rate, console time-out, and screen data refresh interval.
SNMP Configuration	Activates authentication failure traps; and configures communities and trap managers.
User Configuration	Sets the user names and passwords for system access.
TFTP Download	Downloads new version of firmware to update your system (in-band).
Configuration File	Download the configuration to a file or upload the configuration file to the switch.

*1: Only displays on WGS3-2620 when it is set to Layer 2 mode.

4.4.1 Changing the Network Configuration

Use the Network Configuration menu to set the bootup option, configure the switch's Internet Protocol (IP) parameters, or enable the on-board Web agent. The screen shown below is described in the following table.

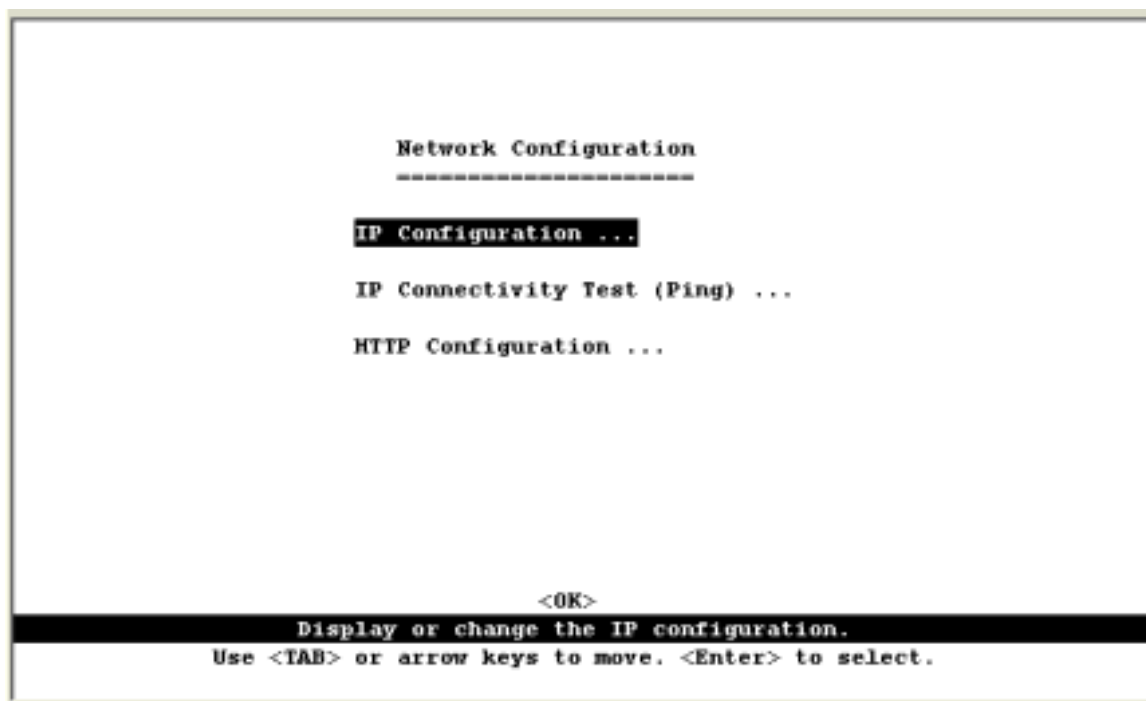

Parameter	Description
IP Configuration*	Screen used to set the bootup option, or configure the switch's IP parameters.
IP Connectivity Test (Ping)	Screen used to test IP connectivity to a specified device.
HTTP Configuration	Screen used to enable the Web agent.

* This menu does not appear on WGS3-404 or if the WGS3-2620 is set to multilayer mode. In this case, you need to configure an IP interface for each VLAN that needs to connect to any device outside of its own VLAN group. (See "Subnet Configuration")

4.4.1.1 IP Configuration (Layer 2 Mode)

Use the IP Configuration screen to set the boot-up option, or configure the switch's IP parameters. The screen shown below is described in the following table.

```
IP Configuration
-----

Interface Type : Ethernet

IP Address   : 203.70.249.118
Subnet Mask  : 255.255.255.0
Gateway IP   : 203.70.249.118
IP State     : USER-CONFIG

Mgt. Access  : All VLANs

<Apply>      <OK>      <Cancel>
IP address of this system for Ethernet. | READ/WRITE
Use <TAB> or arrow keys to move, other keys to make changes. _
```

Parameter	Description
Interface Type	Indicates IP over Ethernet.
IP Address	IP address of the switch you are managing. The system supports SNMP over UDP/IP transport protocol. In this environment, all systems on the Internet, such as network interconnection devices and any PC accessing the agent module must have an IP address. Valid IP addresses consist of four numbers, of 0 to 255, and separated by periods. Anything outside of this format will not be accepted by the configuration program.
Subnet Mask	Subnet mask of the switch. This mask identifies the host address bits used for routing to specific subnets.
Default Gateway	Gateway used to pass trap messages from the system's agent to the management station. Note that the gateway must be defined (when operating at Layer 2) if the management station is located in a different IP segment.
IP State	<p>Specifies whether IP functionality is enabled via manual configuration, or set by Boot Protocol (BOOTP).</p> <p>Options include:</p> <p>USER-CONFIG - IP functionality is enabled based on the default or user specified IP Configuration. (This is the default setting.)</p> <p>BOOTP Get IP - IP is enabled but will not function until a BOOTP reply has been received. BOOTP requests will be periodically broadcasted by the switch in an effort to learn its IP address. (BOOTP values can include the IP address, default gateway, and subnet mask.)</p>
VLAN ID	The VLAN used for management access when "Mgmt VLAN" is selected. See the next item.
Mgt. Access	<p>Specifies which VLAN have access right to its management interface. Options include:</p> <p>All VLANs – All VLANs have access right to its management interface. (This is the default setting.)</p> <p>Mgmt VLAN – Only the specified VLAN have access right to its management interface</p>

4.4.1.2 IP Connectivity Test (Ping)

Use the IP Connectivity Test to see if another site on the Internet can be reached. The screen shown below is described in the following table.

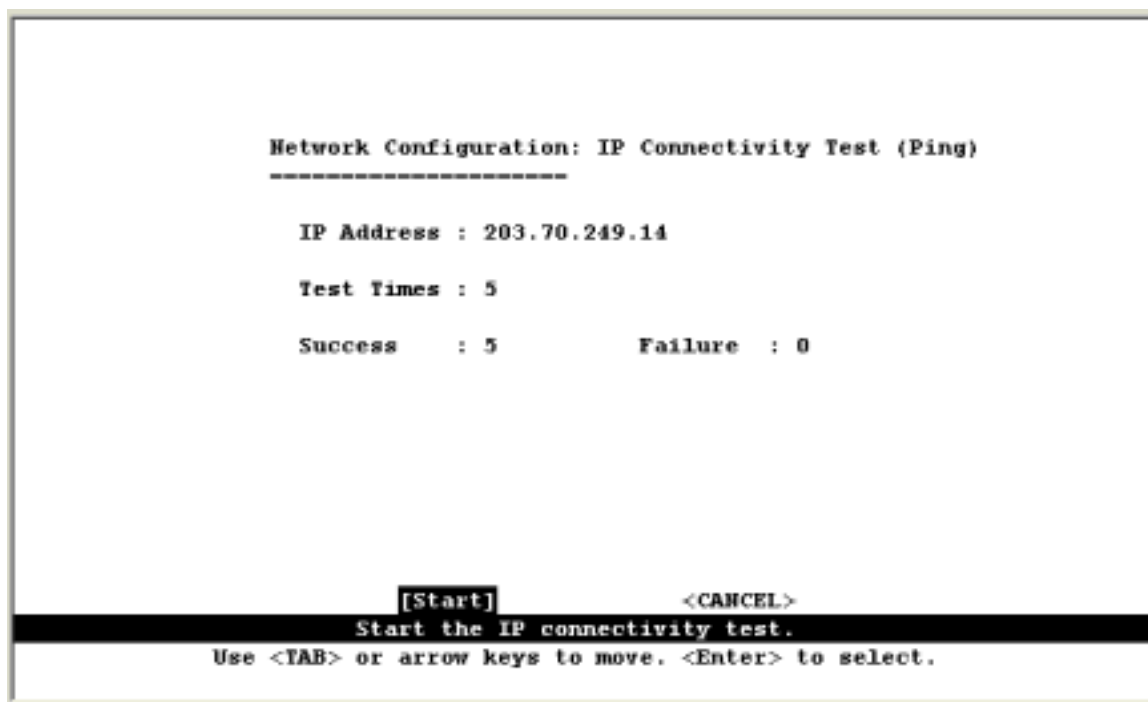

Parameter	Description
IP Address	IP address of the site you want to ping.
Test Times	The number of ICMP echo requests to send to the specified site. Range: 1~1000
Success / Failure	The number of times the specified site has responded or not to pinging.

NOTE: The switch waits up to 10 seconds for a response to each ping.

4.4.1.3 HTTP Configuration

Use the HTTP Configuration screen to enable/disable the on-board Web agent.

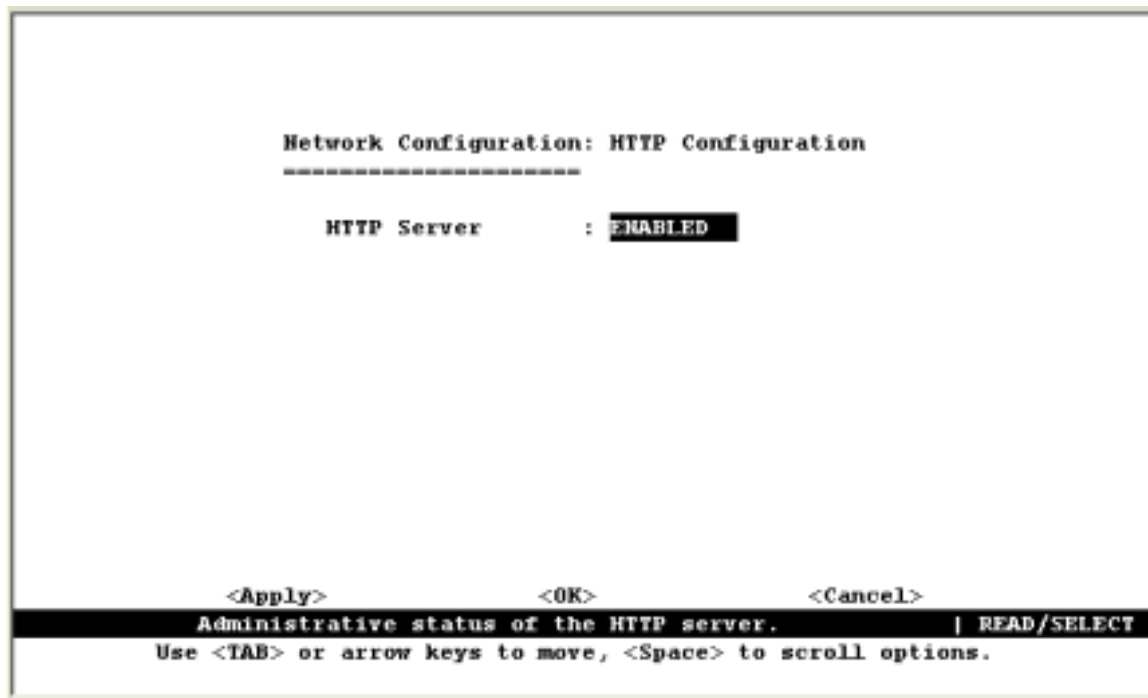

NOTE: Port 80 is used for HTTP service.

4.4.2 Configuring the Serial Port

You can access the on-board configuration program by attaching a VT100 compatible device to the switch's serial port. (For more information on connecting to this port, see "Required Connections" on Section 3.2) The communication parameters for this port can be accessed from the Serial Port Configuration screen shown below and described in the following table.

```
Serial Port Configuration
-----

Management Mode      : CONSOLE MODE
Baud rate            : 19200
Data bits            : 8
Stop bits            : 1
Parity               : NONE
Time-Out (in minutes) : 0
Auto Refresh (in seconds) : 10

<Apply>             <OK>             <Cancel>
The connection mode of the serial port. | READ/SELECT
Use <TAB> or arrow keys to move, <Space> to scroll options.  _
```

Parameter	Default	Description
Management Mode	Console Mode	Indicates that the port settings are for direct console connection.
Baud Rate	19200	The rate at which data is sent between devices. Options : 9600, 19200 and 38400 baud.
Data Bits	8 bits	Sets the data bits of the RS-232 port. Options : 7, 8
Stop Bits	1 bit	Sets the stop bits of the RS-232 port. Options : 1, 2
Parity	None	Sets the parity of the RS-232 port. Options : none/odd/even
Time-Out	0	If no input is received from the attached device after this interval, the current session is automatically closed. Range : 0 - 100 minutes; where 0 indicates disabled
Auto Refresh	10 second	Sets the interval before a console session will auto refresh the console information, such as Spanning Tree Information, Port Configuration, Port Statistics, and RMON Statistics. Range : 0, or 5-255 seconds; where 0 indicates disabled

4.4.3 Assigning SNMP Parameters

Use the SNMP Configuration screen to display and modify parameters for the Simple Network Management Protocol (SNMP). The switch includes an on-board SNMP agent which monitors the status of its hardware, as well as the traffic passing through its ports. A computer attached to the network, called a Network Management Station (NMS), can be used to access this information. Access rights to the on-board agent are controlled by community strings. To communicate with the switch, the NMS must first submit a valid community string for authentication. The options for configuring community strings and related trap functions are described in the following sections.

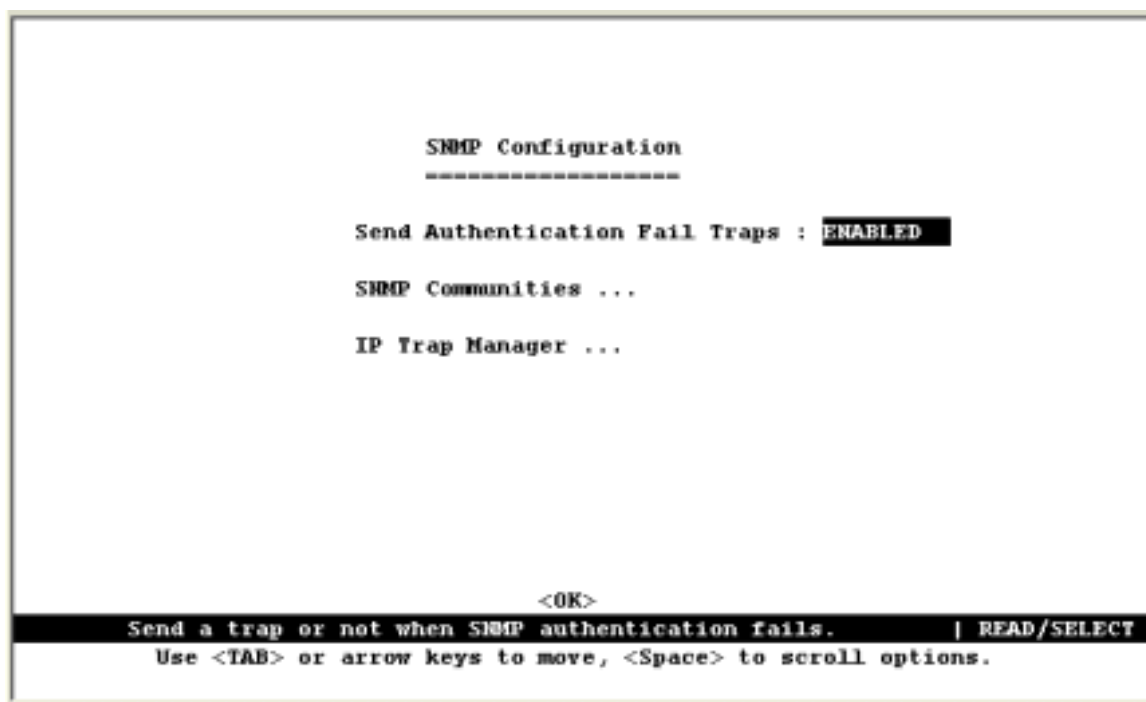

Parameter	Description
Send Authentication Fail Traps	Issue a trap message to specified IP trap managers whenever authentication of an SNMP request fails. (The default is enabled.)
SNMP Communities	Assigns SNMP access based on specified strings.
IP Trap Managers	Specifies management stations that will receive authentication failure messages or other trap messages from the switch.

4.4.3.1 Configuring Community Names

The following figure and table describe how to configure the community strings authorized for management access. Up to 5 community names may be entered.

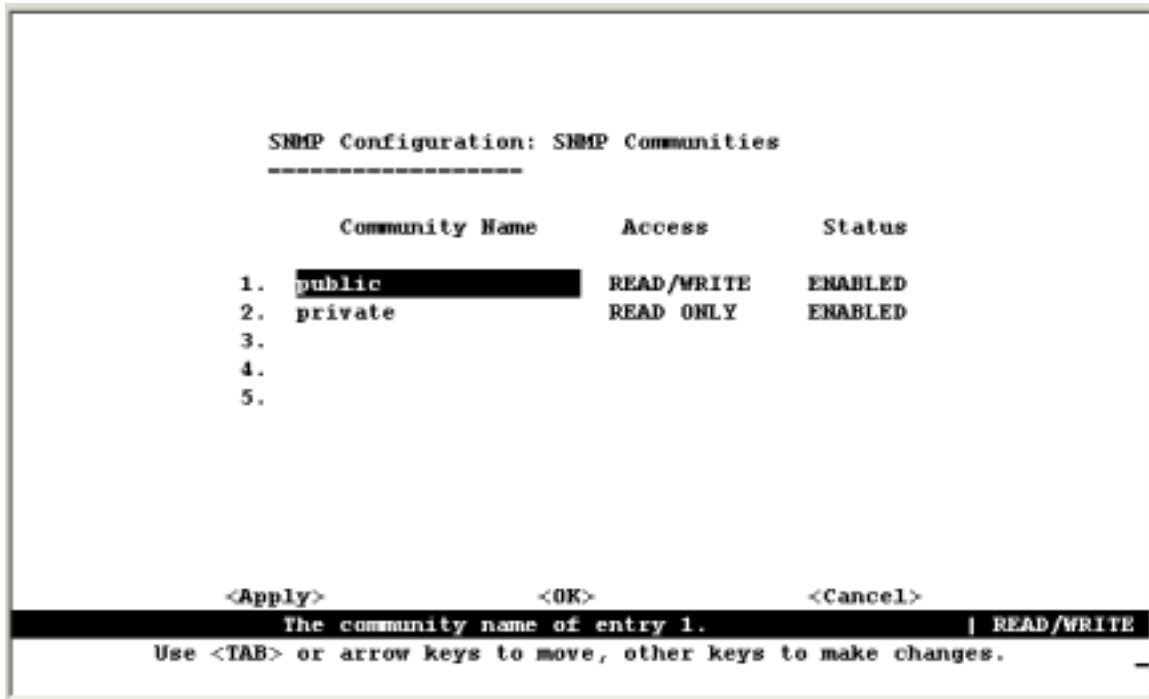

Parameter	Description
Community Name	A community entry authorized for management access. Maximum string length : 19 characters
Access	Management access is restricted to Read Only or Read/ Write.
Status	Sets administrative status of entry to enabled or disabled.

NOTE: The default community strings are displayed on the screen.

4.4.3.2 Configuring IP Trap Managers

The following figure and table describe how to specify management stations that will receive authentication failure messages or other trap messages from the switch. Up to 5 trap managers may be entered.

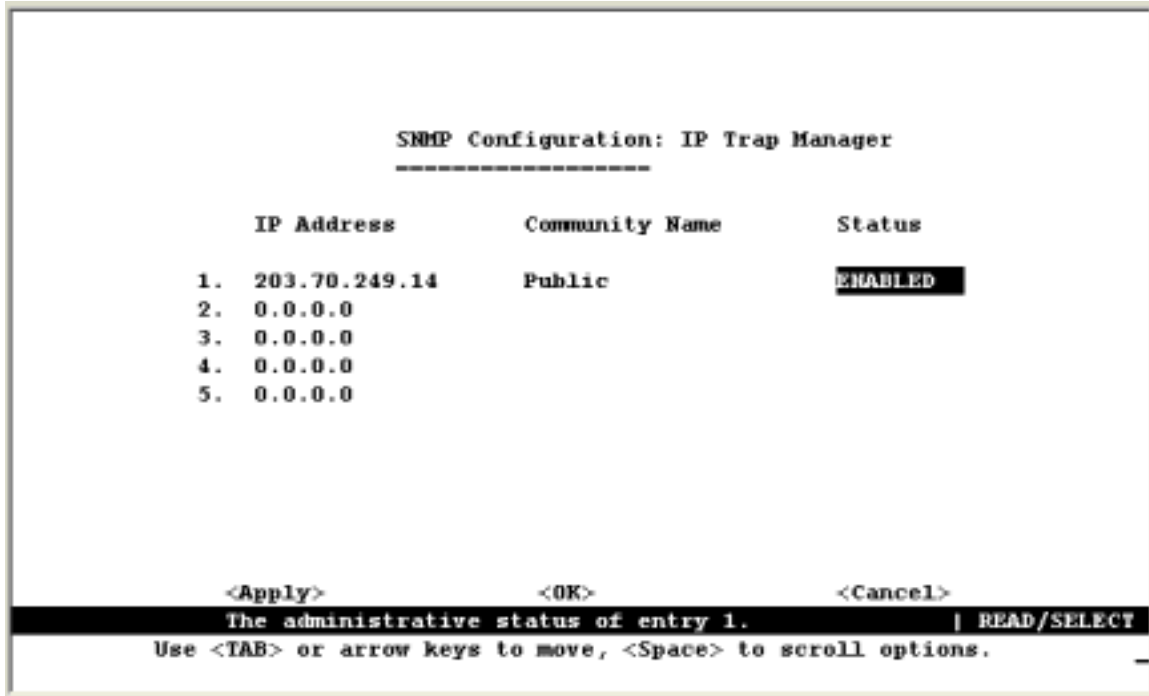

Parameter	Description
IP Address	IP address of the trap manager.
Community Name	A community specified for trap management access.
Status	Sets administrative status of selected entry to enabled or disabled.

4.4.4 User Login Configuration

Use the User Configuration menu to restrict management access based on specified user names and passwords. There are two user types, Administrator and Guest. Only the Administrator has write access for parameters governing the SNMP agent. You should therefore assign a user name and password to the Administrator as soon as possible, and store it in a safe place. (If for some reason your password is lost, or you cannot gain access to the System Configuration Program, contact Technical Support for assistance.) The parameters shown on this screen are indicated in the following figure and table.

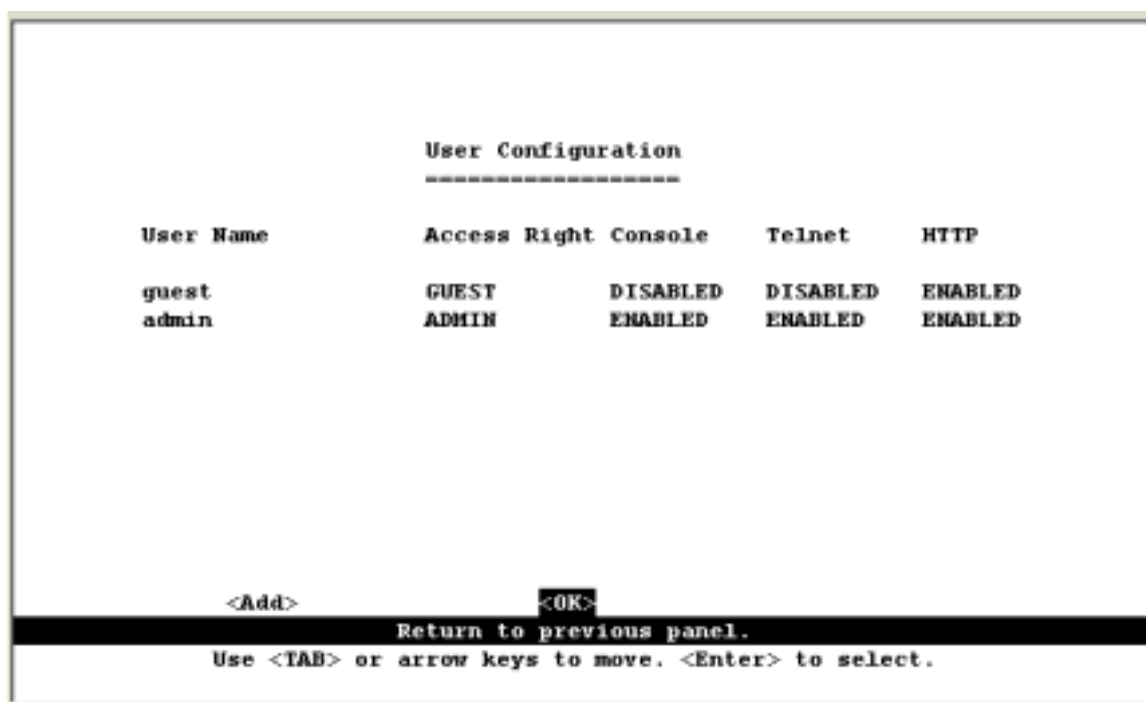

```

User Configuration
-----
User Name      Access Right Console  Telnet  HTTP
guest          GUEST      DISABLED  DISABLED  ENABLED
admin          ADMIN      ENABLED   ENABLED   ENABLED

<Add>          <OK>
Return to previous panel.
Use <TAB> or arrow keys to move. <Enter> to select.

```

Parameter	Description
User Name	Specifies a user authorized management access to the switch via the console, Telnet or HTTP.
Access Right	There are two options. ADMIN: Read/Write for all screens. GUEST: Read Only for all screens.
Console	Authorizes management via the console.
Telnet	Authorizes management via Telnet.
HTTP	Authorizes management via HTTP (that is, Microsoft Internet Explorer 4.0 or later version). It does not support Netscape currently).

To add a new user, select <Add>. When you add a user, the following screen is displayed.

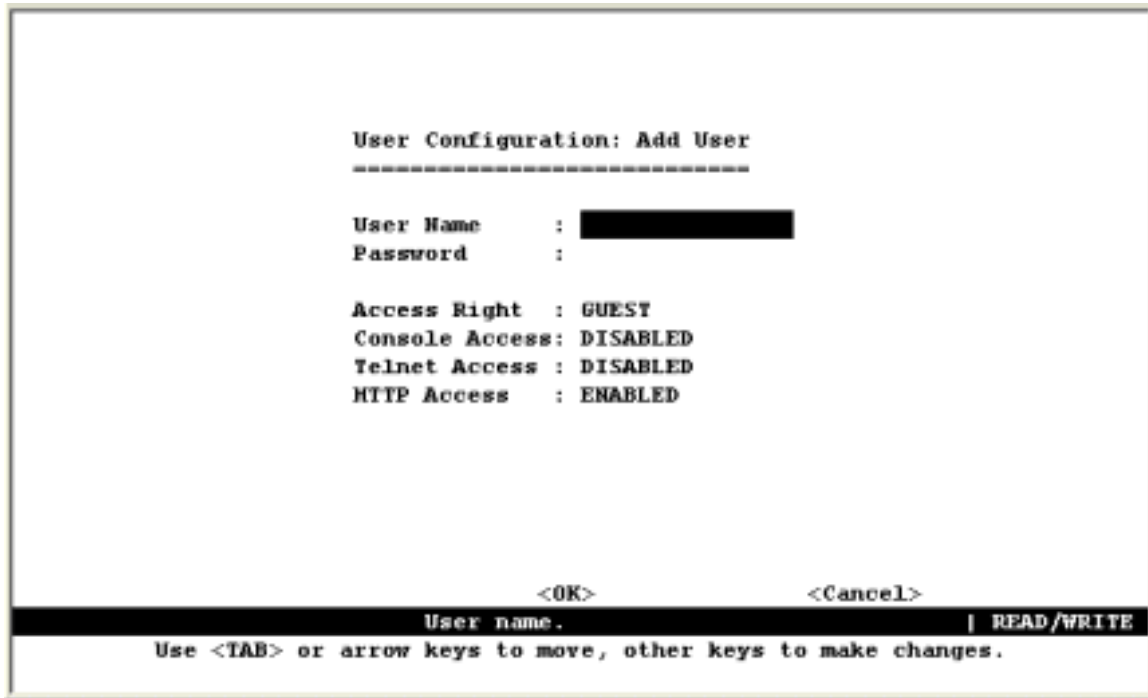

Parameter	Description
User Name*	Specifies a user authorized management access to the switch via the console, Telnet or HTTP.
Password*	Passwords can consist of up to 11 alphanumeric characters and are not case sensitive.
Access Right	ADMIN: Read/Write for all screens. GUEST: Read Only for all screens.
Console Access	Authorizes management via the console.
Telnet Access	Authorizes management via Telnet.
HTTP Access	Authorizes management via HTTP (that is, Microsoft Internet Explorer 4.0 or later version).

* These entries can consist of up to 15 alphanumeric characters and are not case sensitive.

4.4.5 Downloading System Software

Use the TFTP Download menu to load software updates to permanent flash ROM in the switch. The download file should be a 3 binary file or image file; otherwise the agent will not accept it. The success of the download operation depends on the accessibility of the TFTP server and the quality of the network connection. After downloading the new software, the agent will automatically restart itself. Parameters shown on this screen are indicated in the following figure and table.

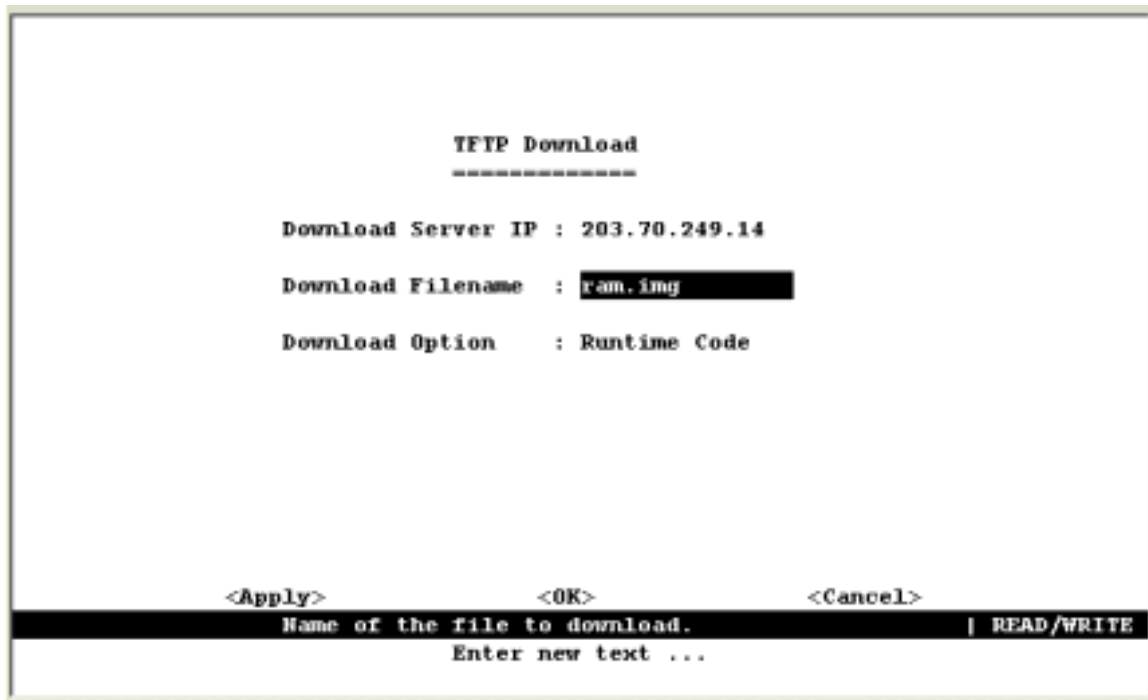

Parameter	Description
Download Server IP	IP address of a TFTP server.
Download Filename	The binary file to download.
Download Option	Specify the file to be Runtime code or POST code.

NOTE: You can also download firmware using the Web agent or by a direct console connection after a restart.

4.4.6 Saving or Restoring the System Configuration

Use the Configuration File menu to save the switch configuration settings to a file on a TFTP client. The file can be later downloaded to the switch to restore the switch's settings. The success of the operation depends on the accessibility of the TFTP client and the quality of the network connection. Parameters shown on this screen are indicated in the following figure and table.

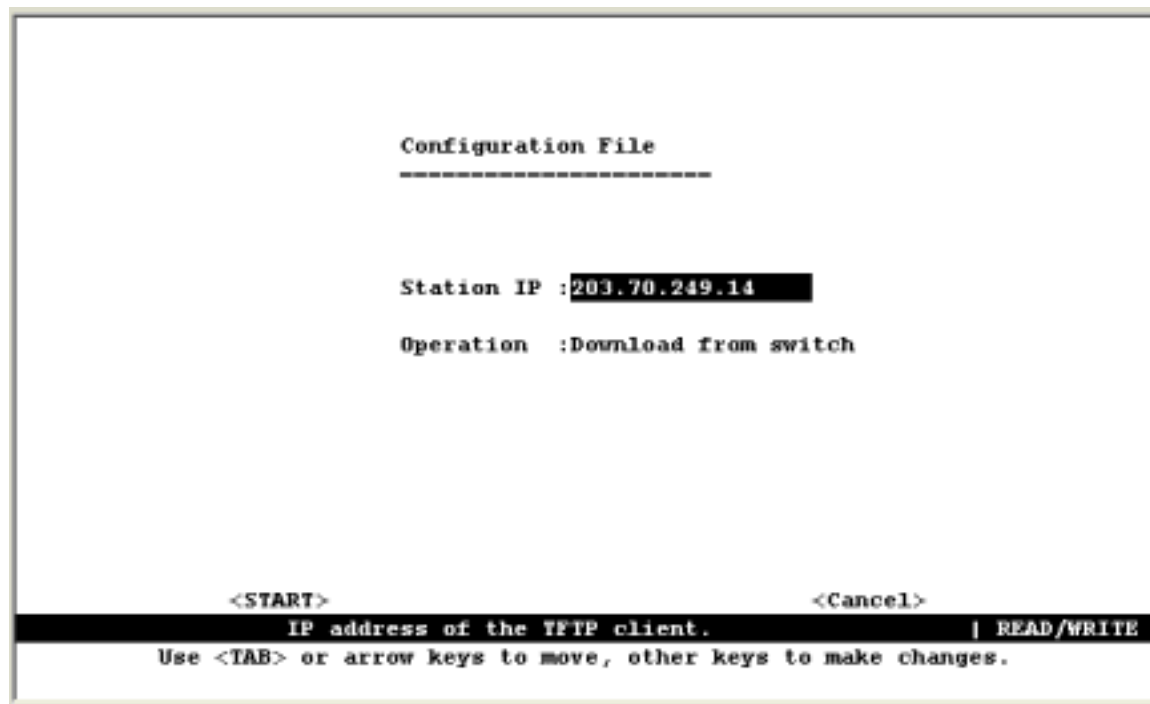

Parameter	Description
Station IP	IP address of a PC running TFTP client software.
Operation	Download from switch – Downloads the current switch configuration to a file on the client PC. Upload to switch – Uploads a configuration file to the switch from the client PC.

Saving and restoring switch configuration settings can be initiated by using any TFTP client utility, such as the command line utility included in Windows NT/2000/XP. For example, using Windows NT, from a DOS window command prompt, enter the TFTP command in the form:

```
TFTP [-i] host [GET : PUT] source [destination]
```

To transfer a file –

On Switch: Specify the IP address of the TFTP client, and select “Download from switch” or “Upload to Switch.” Then select <Start> from the menu to start.

On TFTP Client: Set the mode to <binary>, specify the IP address of the target switch and the directory path / name of the file to transfer. Then start transferring the configuration from the TFTP client or the switch and wait until the transfer completes.

For example, type “tftp -i 203.70.249.118 GET source wgs3.txt” on Windows 2000’s command prompt to download switch’s configuration and type “tftp -i 203.70.249.118 PUT wgs3.txt” to upload the configuration file to switch.

4.5 Device Control Menu

The Device Control menu is used to control a broad range of functions, including port mode, port mirroring, port trunking, Spanning Tree, Virtual LANs, IP subnets, multicast filtering, and routing protocols. Each of the setup screens provided by these configuration menus is described in the following sections.

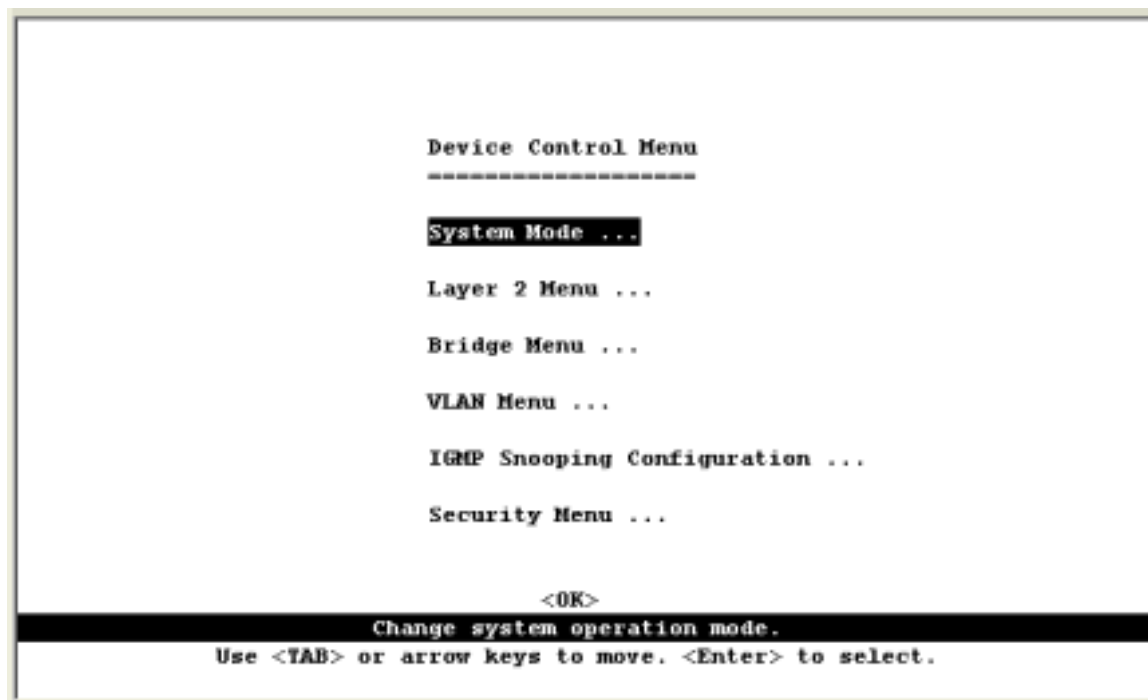

Menu	Description
System Mode	Sets the switch to operate as a Layer 2 switch or as a multilayer routing switch.
Layer 2 Menu	Configures port communication mode, mirror ports, and port trunking.
Bridge Menu	Configures the Spanning Tree Protocol for the bridge or for specific ports, GMRP and GVRP for automatic registration of multicast and VLAN groups, traffic class priority threshold, and address aging time.
VLAN Menu	Configures VLAN settings for specific ports, and defines the port membership for VLAN groups.
IGMP Snooping Configuration ^{*1}	Configures IGMP multicast filtering.
IP Menu ^{*2}	Configures the subnets for each VLAN group, global configuration for unicast and multicast routing protocols, IGMP snooping
Security	Restrict access through MAC address or IP address ^{*2}
Jumbo Packet Menu	Allow the WGS3-404 to send up to 9k jumbo packet

1: Only displayed for Layer 2 mode of WGS3-2620.

2: Only displayed for Multilayer mode of WGS3-2620 and WGS3-404.

3: Only displayed for WGS3-404

4.5.1 Setting the System Operation Mode

WGS3-2620 can be set to operate as a Layer 2 switch, making all filtering and forwarding decisions based strictly on MAC addresses. Or it can be set to operate as a multilayer routing switch, whereby it switches packets for all non-IP protocols (such as NetBUEI, NetWare or AppleTalk) based on MAC addresses, and routes all IP packets based on the specified routing protocol. The System Mode menu is shown below. Note that the switch will be automatically rebooted whenever the system operation mode is changed.



Parameter	Description
Layer 2	Filtering and forwarding decision will be based on MAC addresses for all protocol traffic.
Multilayer	Switching based on MAC addresses will be used for all non-IP protocol traffic, and routing will be used for all IP protocol traffic.

NOTE: When the switch is set to multilayer mode, the IP menus are enabled, and the "IP Configuration (Layer 2 Mode)" menu is disabled. When operating in multilayer mode, you should configure an IP interface for each VLAN that needs to communicate with any device outside of the VLAN. (See "Subnet Configuration")

4.5.2 Layer 2 Menu

The Layer 2 menu contains options for port configuration, port mirroring, port trunking and static unicast/multicast address configuration. These menu options are described in the following sections.

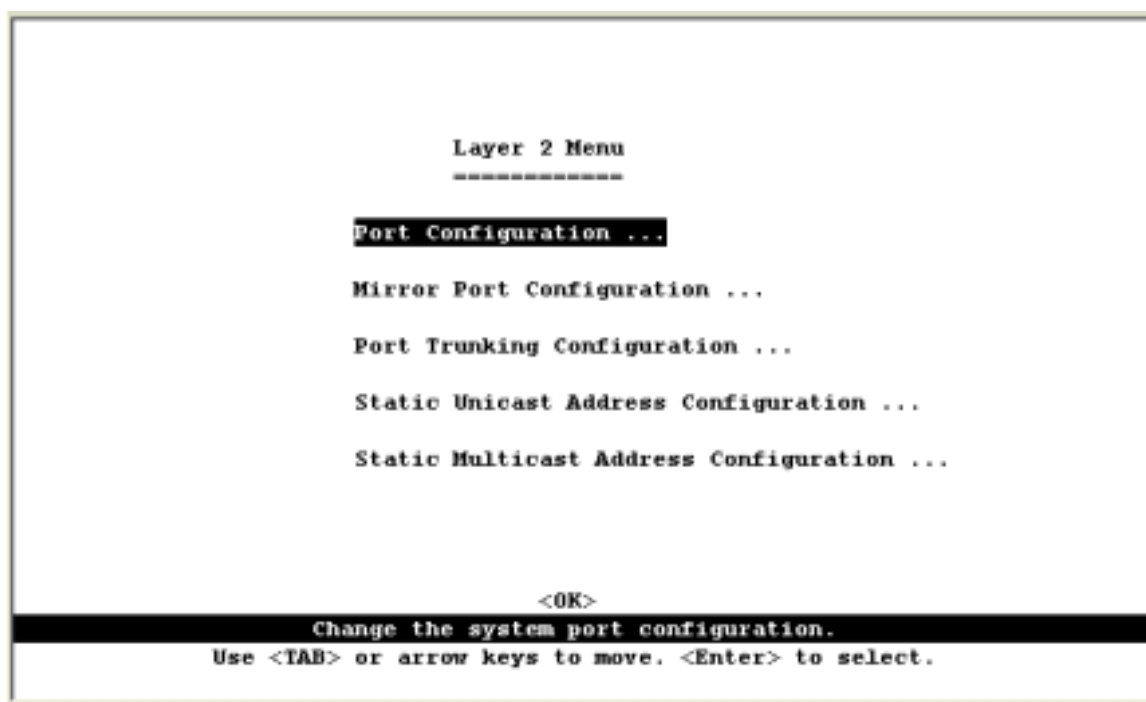

Menu	Description
Port Configuration	Enables any port, enables/disables flow control, and sets communication mode to auto-negotiation, full duplex or half duplex.
Mirror Port Configuration	Sets the source and target ports for mirroring.
Port Trunking Configuration	Specifies ports to group into aggregate trunks.
Static Unicast Address Configuration	Used to manually configure host MAC addresses in the unicast table.
Static Multicast Address Configuration	Used to manually configure host MAC addresses in the multicast table.

4.5.2.1 Configuring Port Parameters

Use the Port Configuration menu to display or set communication parameters for any port on the switch, including administrative status, auto-negotiation, default communication speed and duplex mode, as well as flow control in use.

Layer 2 Menu: Port Configuration (Port 1-12)							
Port	Link Status	Admin Status	Auto Negotiate	Default Type	Current Type	Flow Control	Jack Type
1	Off	ENABLED	ENABLED	10HDX	10HDX	Off	RJ-45
2	Off	ENABLED	ENABLED	10HDX	10HDX	Off	RJ-45
3	Off	ENABLED	ENABLED	10HDX	10HDX	Off	RJ-45
4	Off	ENABLED	ENABLED	10HDX	10HDX	Off	RJ-45
5	Off	ENABLED	ENABLED	10HDX	10HDX	Off	RJ-45
6	Off	ENABLED	ENABLED	10HDX	10HDX	Off	RJ-45
7	Off	ENABLED	ENABLED	10HDX	10HDX	Off	RJ-45
8	Off	ENABLED	ENABLED	10HDX	10HDX	Off	RJ-45
9	Off	ENABLED	ENABLED	10HDX	10HDX	Off	RJ-45
10	Off	ENABLED	ENABLED	10HDX	10HDX	Off	RJ-45
11	Off	ENABLED	ENABLED	10HDX	10HDX	Off	RJ-45
12	Off	ENABLED	ENABLED	10HDX	10HDX	Off	RJ-45

<Apply> <OK> <Cancel> <Prev Page> <Next Page>

Administrative status for port 1. | READ/SELECT

Use <TAB> or arrow keys to move, <Space> to scroll options.

Parameter	Default	Description
Link Status		Indicates if the port has a valid connection to an external device.
Admin Status	Enabled	Allows you to disable a port due to abnormal behavior (e.g., excessive collisions), and then re-enable it after the problem has been resolved. You may also disable a port for security reasons.
Auto Negotiate	Enabled	Enables or disables auto-negotiation for port speed, duplex mode, and flow control.
Default Type	10HDX	If auto-negotiation is disabled, the port will be set to the indicated speed and duplex mode.
Current Type		Indicates the current speed and duplex mode.
Flow Control	Off	Used to enable or disable flow control. Flow control can eliminate frame loss by “blocking” traffic from end stations or segments connected directly to the switch when its buffers fill. When enabled, back pressure is used for half duplex and IEEE 802.3x for full duplex. Note that flow control should not be used if a port is connected to a hub.
Jack Type	RJ-45 or SC	Shows the jack type for each port.

4.5.2.2 Using a Mirror Port for Analysis

You can mirror traffic from any source port to a target port for real-time analysis. You can then attach a logic analyzer or RMON probe to the target port and study the traffic crossing the source port in a completely unobtrusive manner. When mirroring port traffic, note that the target port must be included in the same VLAN as the source port. (See “Configuring Virtual LANs”)

You can use the Port Mirror Configuration screen to mirror one or more ports to the monitor port as shown below.

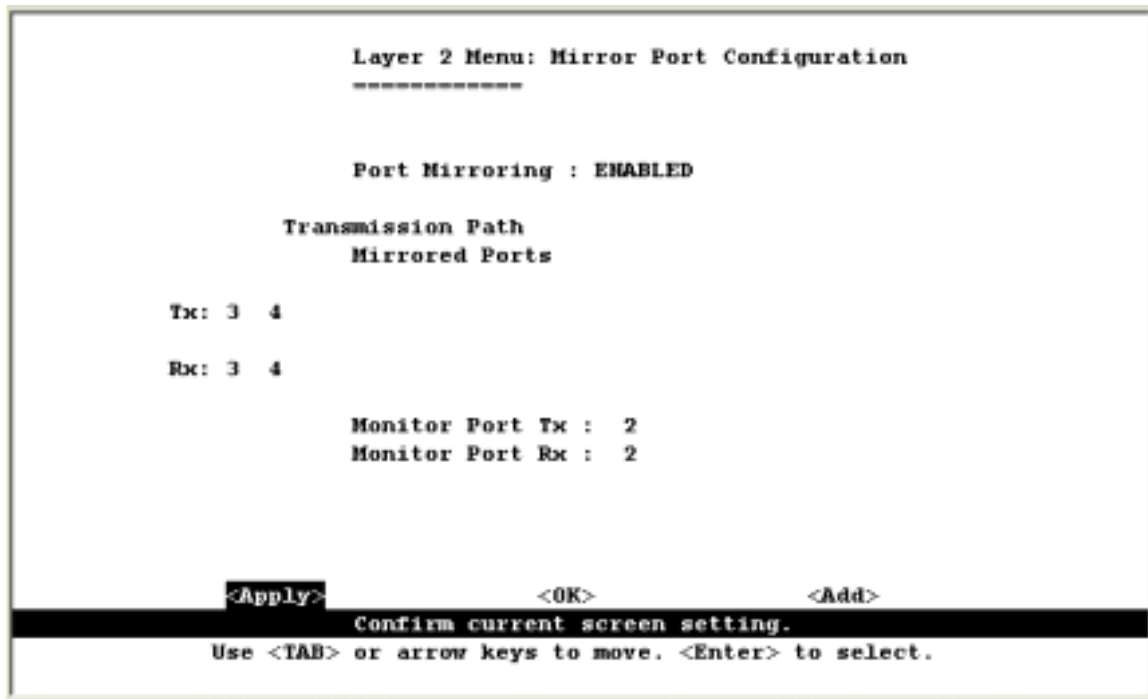

Parameter	Description
Port Mirroring	Enables or disables the mirror function.
Mirrored Ports (Tx/Rx)	The port whose transmitted or received traffic will be mirrored. Press Add to specify mirrored ports.
Monitor Port	The port that will duplicate the transmitted or received traffic appearing on the mirrored port.

NOTE: You can mirror multiple ports to a single port to view traffic on WGS3-2620. However, note that some packets may be dropped for moderate to heavy loading.

4.5.2.3 Configuring Port Trunks

Ports can be combined into an aggregate link to increase the bandwidth of a network connection or ensure fault recovery. You can configure trunks between any two switches. The ports on this switch can be grouped into a trunk consisting of two, four or eight ports, creating an aggregate bandwidth to 400, 800, 1600, 4000 or 8000 Mbps when operating at full duplex. Besides balancing the load across each port in the trunk, the additional ports provide redundancy by taking over the load if another port in the trunk should fail. However, before making any physical connections between devices, use the Port Trunking Configuration menu to specify the trunk on the devices at both ends. When using a port trunk, remember that::

- The ports that can be assigned to the same trunk on WGS3-2620 are listed below:

Two ports as a trunk

<<13, 01>> <<14, 02>> <<15, 03>> <<16, 04>>
<<17, 05>> <<18, 06>> <<19, 07>> <<20, 08>>
<<21, 09>> <<22, 10>> <<23, 11>> <<24, 12>>

Four ports as a trunk

<<13, 01, 14, 02>> <<15, 03, 16, 04>>
<<17, 05, 18, 06>> <<19, 07, 20, 08>>
<<21, 09, 22, 10>> <<23, 11, 24, 12>>

Eight ports as a trunk

<<13, 01, 14, 02, 15, 03, 16, 04>>
<<17, 05, 18, 06, 19, 07, 20, 08>>
<<21, 09, 22, 10, 23, 11, 24, 12>>

Gigabit Ethernet Ports as a trunk

<<25, 26>>

- The ports that can be assigned to the same trunk on WGS3-404 are listed below:

Two ports as a trunk

<<1, 2>> <<3, 4>> <<5, 6>> <<7, 8>>

Four ports as a trunk

<<1, 2, 3, 4>> <<5, 6, 7, 8>>

- Ports can only be assigned to one trunk.
- The ports at both ends of a connection must be configured as trunk ports.
- The ports at both ends of a trunk must be configured in an identical manner, including communication mode, and VLAN assignments.
- None of the ports in a trunk can be configured as a mirror or monitor port.
- All the ports in a trunk have to be treated as a whole when moved from/to, added or deleted from a VLAN.
- The Spanning Tree Algorithm will treat all the ports in a trunk as a whole.
- Enable the trunk prior to connecting any cable between the switches to avoid creating a loop.

4.5.2.4 Configuring the Static Unicast Address Table

The Static Unicast Address Table can be used to assign the MAC address for a host device to a specific port on this switch. Static unicast addresses are never aged out, and cannot be learned on another port. If any packets with a source address specified in this table enter another port, they will be dropped. The Static Unicast Address Table is described in the following figure and table.

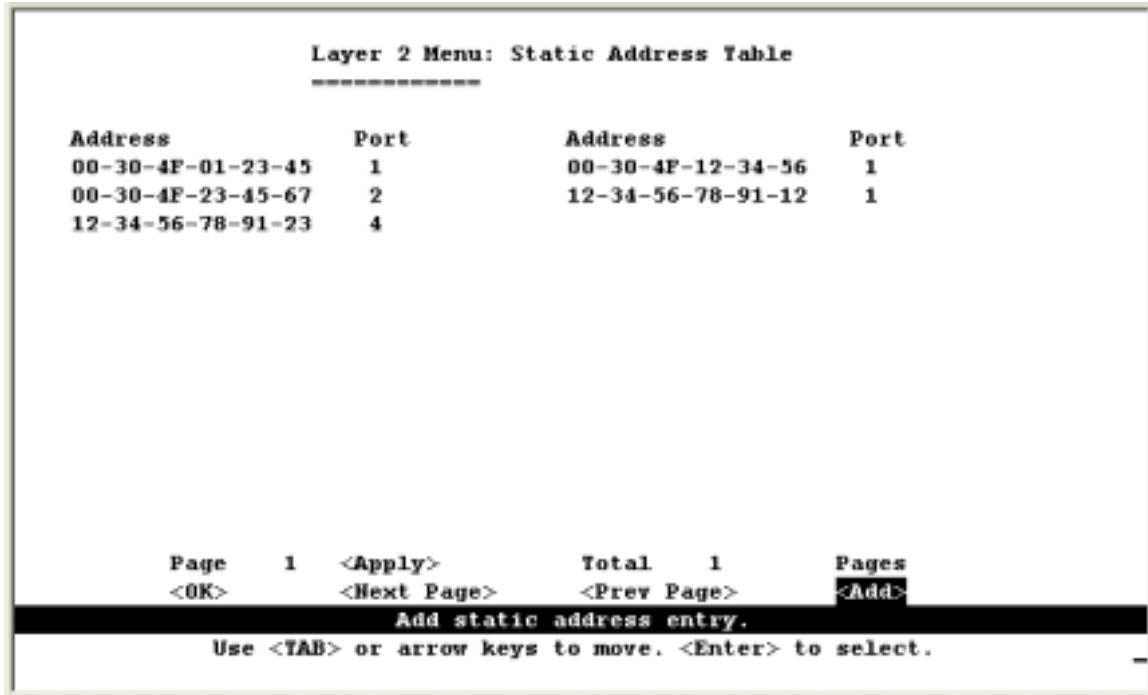

Parameter	Description
Address	The MAC address of a host device attached to this switch.
Port	The switch port the host device is attached to.

NOTE: To assign a MAC address to a specific port, use <Add>. To delete or modify an address, highlight it with the cursor and press Enter. To scroll through the address table, use the <Next Page> and <Prev Page> buttons. To display a specific page, set the page number in the Page field and then press <Apply>.

4.5.2.5 Configuring the Static Multicast Address Table

The Static Multicast Address Table can be used to assign a destination MAC address (and the corresponding ports) to the VLAN group used for a specific multicast service. Static multicast addresses are never aged out, and traffic with these addresses can only be forwarded to ports specified in this table.

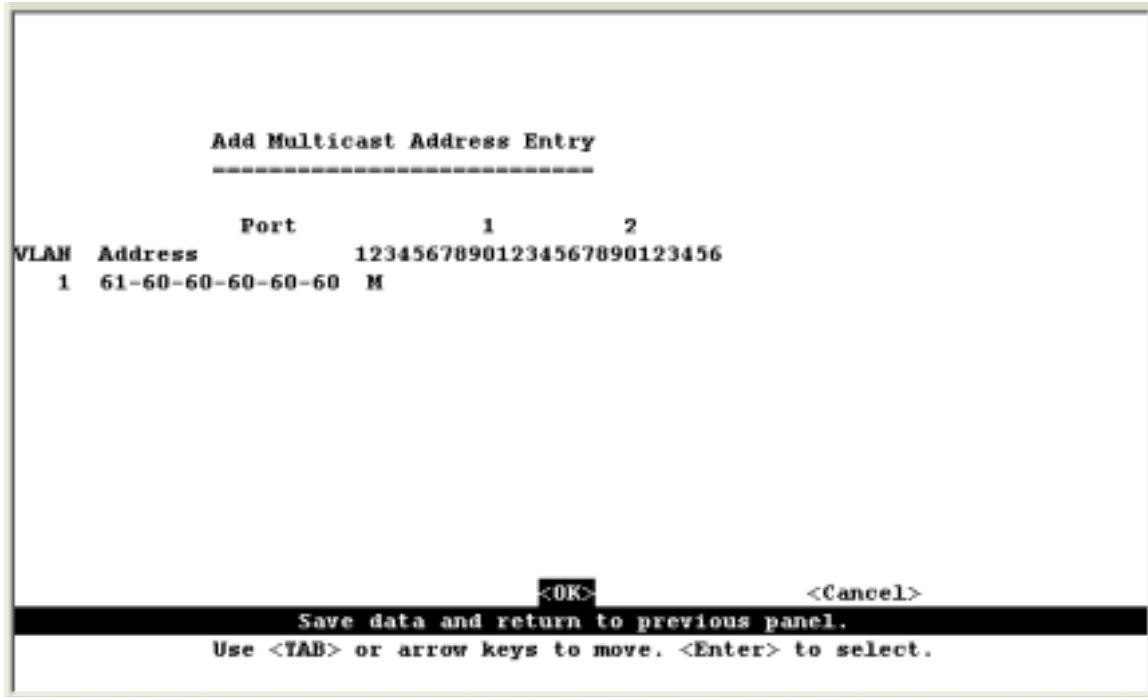

Parameter	Description
VLAN	The VLAN corresponding to this multicast service.
Address	The destination MAC address for a multicast service.
Port	The ports to which this multicast traffic can be forwarded.

NOTE: To assign a destination MAC address to one or more ports, use <Add>. To delete or modify an address, highlight it with the cursor and press Enter. To scroll through the address table, use the <Next Page> and <Prev Page> buttons. To display a specific page, set the page number in the Page field and then press <Apply>.

4.5.3 Using the Bridge Menu

The Bridge menu is used to display or configure settings for the Spanning Tree Algorithm, as well as the global bridge settings for GMRP (GARP Multicast Registration Protocol) and GVRP (GARP VLAN Registration Protocol), traffic classes priority threshold, and address aging time.

The Spanning Tree Algorithm can be used to detect and disable network loops, and to provide backup links between switches, bridges or routers. This allows the switch to interact with other bridging devices (that is, an STA-compliant switch, bridge or router) in your network to ensure that only one route exists between any two stations on the network, and provide backup links that automatically take over when a primary link goes down. For a more detailed description of how to use this algorithm, refer to “Spanning Tree Algorithm” on Chapter “Advanced Topics”.



Menu	Description
Bridge Configuration	Contains global bridge settings for STA (including bridge priority, hello time, forward delay, maximum message age), GMRP, GVRP, traffic class priority threshold, and address aging time.
Spanning Tree Port Configuration	Contains STA settings for individual ports, including port priority, path cost, and fast forwarding

4.5.3.1 Configuring Global Bridge Settings

The following figure and table describe bridge configuration for STA, GMRP, GVRP, priority threshold, and address aging time.

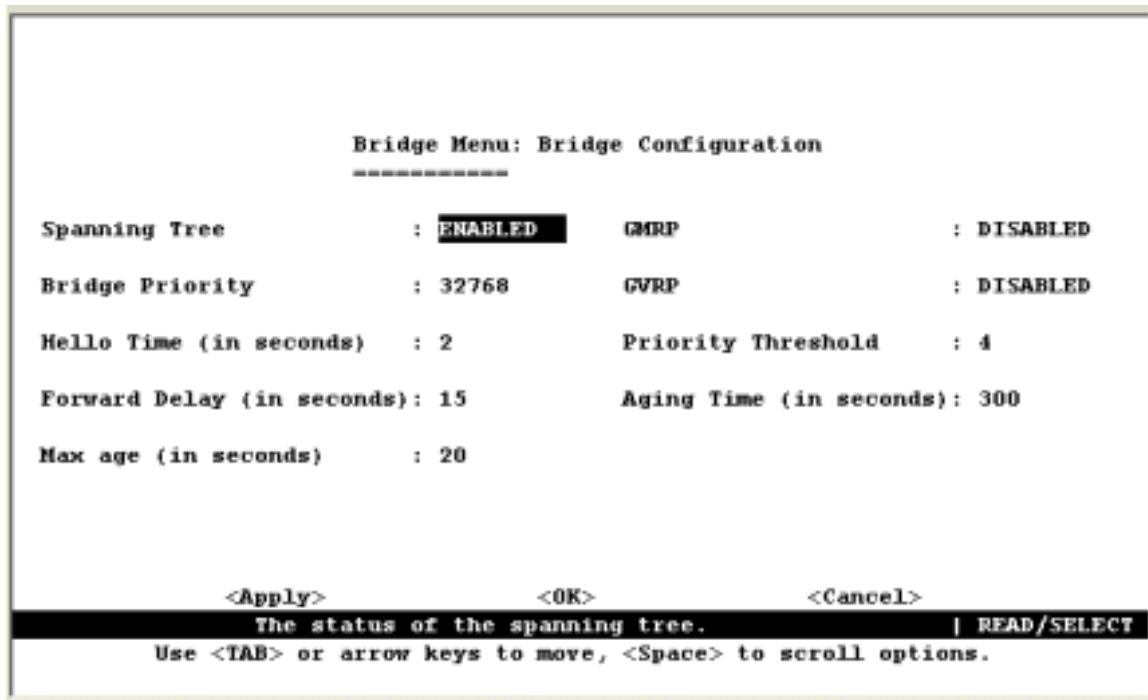

Parameter	Default	Description
Spanning Tree	Enabled	Enable this parameter to participate in a STA compliant network.
Bridge Priority	32,768	<p>Bridge priority is used in selecting the root device, root port, and designated port. The device with the highest priority becomes the STA root device. However, if all devices have the same priority, the device with the lowest MAC address will then become the root device.</p> <p>Enter a value from 0 - 65535.</p> <p>Remember that the lower the numeric value, the higher the priority.</p>
Hello Time	2	<p>Time interval (in seconds) at which the root device transmits a configuration message.</p> <p>The minimum value is 1.</p> <p>The maximum value is the lower of 10 or</p> <p>$[(\text{Max. Message Age} / 2) - 1]$.</p>

Forward Delay	15	<p>The maximum time (in seconds) the root device will wait before changing states (that is, listening to learning to forwarding). This delay is required because every device must receive information about topology changes before it starts to forward frames. In addition, each port needs time to listen for conflicting information that would make it return to a blocking state; otherwise, temporary data loops might result.</p> <p>The maximum value is 30.</p> <p>The minimum value is the higher of 4 or $[(\text{Max. Message Age} / 2) + 1]$.</p>
Max (Message) Age	20	<p>The maximum time (in seconds) a device can wait without receiving a configuration message before attempting to reconfigure. All device ports (except for designated ports) should receive configuration messages at regular intervals. Any port that ages out STA information (provided in the last configuration message) becomes the designated port for the attached LAN. If it is a root port, a new root port is selected from among the device ports attached to the network.</p> <p>The minimum value is the higher of 6 or $[2 \times (\text{Hello Time} + 1)]$.</p> <p>The maximum value is the lower of 40 or $[2 \times (\text{Forward Delay} - 1)]$.</p>
GMRP ^{*1}	Disabled	<p>GARP Multicast Registration Protocol (GMRP) allows network devices to register end stations with multicast groups. If GMRP is globally enabled for the switch, then you can individually enable or disable GMRP for a specific port. See “4.5.4.1 VLAN Port Configuration”.</p> <p>IGMP and IGMP Snooping also provide multicast filtering. For multilayer mode, the full IGMP protocol set is automatically enabled/disabled along with DVMRP. (See “6.4.2 IGMP Protocol”, and “4.5.5 Configuring IGMP Snooping”.)</p>
GVRP	Disabled	<p>GARP VLAN Registration Protocol (GVRP) defines a way for switches to exchange VLAN information in order to register VLAN members on ports across the network. This function should be enabled to permit automatic VLAN registration, and to support VLANs which extend beyond the local switch.</p> <p>If GVRP is globally enabled for the switch, then you can individually enable or disable GVRP for a specific port. See “4.5.4.1 VLAN Port Configuration”.</p>
Priority Threshold ^{*1}	4	<p>WGS3-2620 supports Quality of Service (QoS) by using two priority queues, with Weighted Fair Queuing for each port. Up to 8 separate traffic classes are defined in IEEE 802.1p. So any packets with a priority equal to or higher than this threshold are placed in the high priority queue. You can use “4.5.4.1 VLAN Port Configuration” to configure the default priority for each port.</p>

High/Medium/ Low Priority ²	6/4/2	WGS3-404 supports Quality of Service (QoS) by using four priority queues (High, Medium, Low and Lowest), with Weighted Fair Queuing for each port. Up to 8 separate traffic classes are defined in IEEE 802.1p. So any packets with a priority equal to or higher than High Priority (default is 6) are placed in the high priority queue and so do others. Any packets with a priority lower than Low Priority (default is 2) are placed in the lowest priority queue. You can use "4.5.4.1 VLAN Port Configuration" to configure the default priority for each port.
Aging Time	300	Time-out period in seconds for aging out dynamically learned MAC addresses information. Range: 10 - 1000000 seconds

1: Only displayed on WGS3-2620.

2: Only displayed on WGS3-404

4.5.3.2 Configuring STA for Ports

The following figure and table describe port STA configuration.

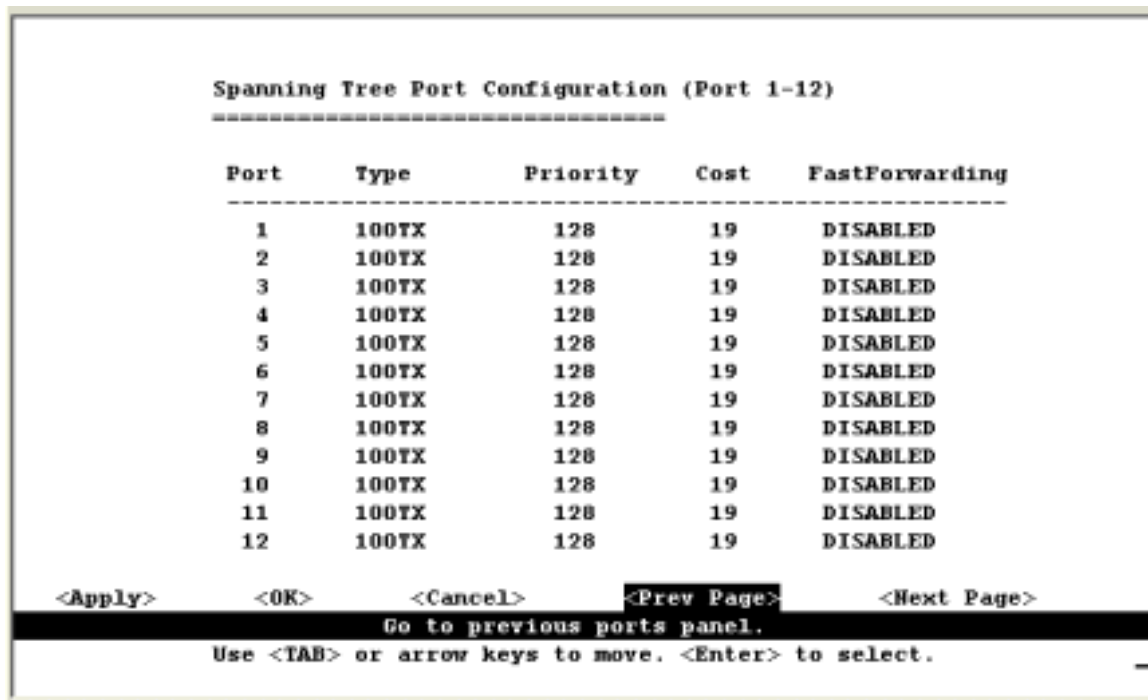

Port	Type	Priority	Cost	FastForwarding
1	100TX	128	19	DISABLED
2	100TX	128	19	DISABLED
3	100TX	128	19	DISABLED
4	100TX	128	19	DISABLED
5	100TX	128	19	DISABLED
6	100TX	128	19	DISABLED
7	100TX	128	19	DISABLED
8	100TX	128	19	DISABLED
9	100TX	128	19	DISABLED
10	100TX	128	19	DISABLED
11	100TX	128	19	DISABLED
12	100TX	128	19	DISABLED

<Apply> <OK> <Cancel> **<Prev Page>** <Next Page>

Go to previous ports panel.

Use <TAB> or arrow keys to move. <Enter> to select.

Parameter	Default	Description
Type		Shows port type as: 100TX : 10BASE-T / 100BASE-TX 1000T : 1000BASE-T 1000FX: 1000Base-SX or 1000Base-LX
Priority	128	Defines the priority for the use of a port in the STA algorithm. If the path cost for all ports on a switch are the same, the port with the highest priority (that is, lowest value) will be configured as an active link in the Spanning Tree. Where more than one port is assigned the highest priority, the port with lowest numeric identifier will be enabled. The range is 0 - 255.
(Path) Cost	100/19/4	This parameter is used by the STA algorithm to determine the best path between devices. Therefore, lower values should be assigned to ports attached to faster media, and higher values assigned to ports with slower media. (Path cost takes precedence over port priority.) The default and recommended range is: Ethernet: 100 (50~600) Fast Ethernet: 19 (10~60) Gigabit Ethernet: 4 (3~10) The full range is 0 - 65535.
Fast Forwarding	Disabled	This parameter is used to enable/disable the Fast Spanning Tree mode for the selected port. In this mode, ports skip the Blocked, Listening and Learning states and proceed straight to Forwarding.

NOTE: Since end-nodes cannot cause forwarding loops, they can pass through the Spanning Tree state changes more quickly than allowed by standard convergence time. Fast Forwarding can achieve quicker convergence for end-node workstations and servers, and also overcome other STA related time-out problems. (Remember that Fast Forwarding should only be enabled for ports connected to an end-node device.)

4.5.4 Configuring Virtual LANs

You can use the VLAN configuration menu to assign any port on the switch to any of up to 256 Virtual LAN groups. In conventional networks with routers, broadcast traffic is split up into separate domains. Switches do not inherently support broadcast domains. This can lead to broadcast storms in large networks that handle traffic such as IPX or NetBEUI. By using IEEE 802.1Q compliant VLANs, you can organize any group of network nodes into separate broadcast domains, confining broadcast traffic to the originating group. This also provides a more secure and cleaner network environment. For more information on how to use VLANs, see "6.3 Virtual LANs". The VLAN configuration screens are described in the following sections.

4.5.4.1 VLAN Port Configuration

You can use the VLAN Port Configuration screen to configure GARP, the default VLAN identifier, default port priority, VLAN tagging on the attached link, GVRP and GMRP status, and filtering of incoming frames for VLAN groups to which this port does not belong.

```
VLAN Menu: VLAN Port Configuration
-----

GARP Configuration

Join Time      20 Centiseconds
Leave Time     60 Centiseconds
Leave All Time 1000 Centiseconds

VLAN and Priority

Port VID          1
Port Default Priority 0
VLAN Tagging     Rx All, Tx Untag
GVRP             ENABLED
GMRP             ENABLED
Ingress Filtering  DISABLED

Port 1 <Apply> <OK> <Cancel> <Prev Port> <Next Port>
The join time for the port. | READ/WRITE
Use <TAB> or arrow keys to move, other keys to make changes.
```

Parameter	Default	Description
GARP ^{*1}		Group Address Registration Protocol is used by GVRP and GMRP to register or deregister client attributes for client services within a bridged LAN.
Join Time	20	The interval (centiseconds) between transmitting requests/queries to participate in a group.
Leave Time	60	The interval (centiseconds) a port waits before leaving a group. This time should be set to more than twice the Join Time. This ensures that after a Leave or LeaveAll message has been issued, the applicants can re-join before the port actually leaves the group.
Leave All Time	1000	The interval (centiseconds) between sending out a LeaveAll query message for group participants and the port leaving the group. This interval should be considerably larger than the Leave Time to minimize the amount of traffic generated by nodes rejoining the group.

1: The default values for the GARP timers are independent of the media access method or data rate. These values should not be changed unless you are experiencing some difficulties with GMRP or GVRP registration/deregistration.

Parameter	Default	Description
VLAN and Priority		These fields set the default values for VLANs, port priority, GVRP and GMRP.
Port VID	1	The VLAN ID assigned to untagged frames received on this port.
Port Default Priority ^{*2}	0	Set the default ingress priority to any value beneath the priority threshold to specify the low priority queue, or to any value equal to or above this threshold to specify the high priority queue.
VLAN Tagging Layer 2 - ^{*3}		Indicates whether or not VLAN tags will be included on frames passing through this port. The options include:
Rx All,		Rx All: Accepts all frames, tagged or untagged.
Tx All		Rx Untag: Only accepts untagged frames.
Multilayer -		Tx All: If PVID and frame tag are same, sends tagged frame, otherwise sends untagged.
Rx All,		
Tx Untag		Tx Untag: Sends only untagged frames.

2: The switch supports Quality of Service (QoS) by using two or four priority queues, with Weighted Fair Queuing for each port. Inbound frames that do not have VLAN tags are tagged with the input port's default ingress user priority, and then placed in the appropriate priority queue at the output port. The default priority for all ingress ports is zero. Therefore, any inbound frames that do not have priority tags will be placed in the low priority queue of the output port. (Note that if the output port is an untagged

member of the associated VLAN, these frames are stripped of all VLAN tags prior to transmission.)

3: If you want to create a small port-based VLAN for just one or two switches, you can assign ports to the same untagged VLAN (and use a separate connection where a VLAN crosses the switches). However, to participate in a VLAN group that extends beyond this switch, we recommend using the VLAN ID for that group (using VLAN tagging for Layer 2 mode, or a common PVID for multilayer mode).

When operating the switch in Layer 2 mode, ports assigned to a large VLAN group that crosses several switches must use VLAN tagging. But when operating in multilayer mode, this switch does not currently support tagging, so you should set the PVID to the same value at both ends of the link (if the device you are attaching to is VLAN-aware), and configure an IP interface for this VLAN if you need to connect it to other group.

This parameter is for WGS3-2620 only. WGS3-404's default setting is Rx All and use VLAN Table Configuration for Tx.

Parameter	Default	Description
GVRP	Enabled	Enables or disables GVRP for this port. When disabled, any GVRP packets received on this port will be discarded and no GVRP registrations will be propagated from other ports. Note that GVRP must be enabled globally for the switch before this setting can take effect. (See "4.5.3.1 Configuring Global Bridge Settings")
GMRP ^{*4}	Enabled	Enables or disables GMRP for this port. When enabled, this port will allow end stations to register with multicast groups using GMRP. Note that GMRP must be enabled for the switch before this setting can take effect. IGMP and IGMP Snooping also provide multicast filtering. (See "6.4.2 IGMP Protocol")
Ingress Filtering ^{*5}	Disabled	If enabled, incoming frames for VLANs which do not include this ingress port in their member set will be discarded at the ingress port.

4: Only displayed on WGS3-2620.

5: This control does not affect VLAN independent BPDU frames, such as GVRP or STP. However, they do affect VLAN dependent BPDU frames, such as GMRP.

4.5.4.2 VLAN Table Configuration

Use this screen to create a new VLAN or modify the settings for an existing VLAN.

The VLAN Table Configuration of WGS3-2620 and WGS3-404 are slightly different. For WGS3-2620, the VLAN Table Configuration is as the following:

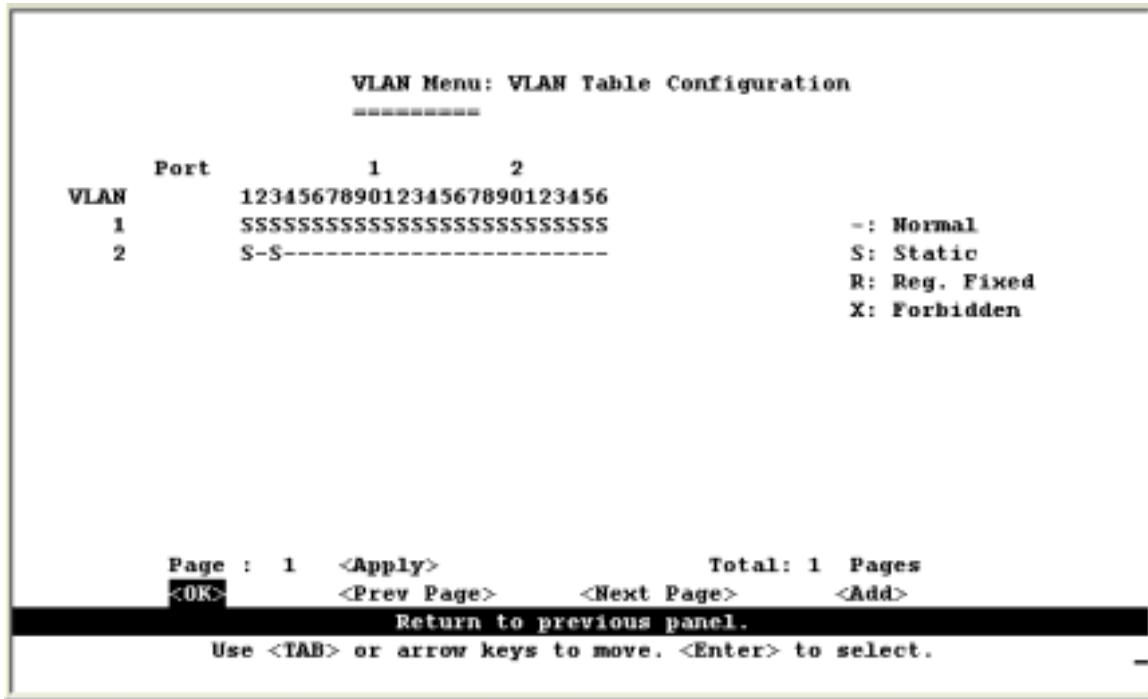

The configuration parameter for WGS3-2620 is as the following:

Parameter	Description
VLAN	The ID for the VLAN currently displayed. Range: 1-4094
Port	Port entries may be marked as: - : (Normal) Uses GVRP to determine port membership. S : (Static) Adds port as a static entry. GVRP protocol is disabled. R : (Registration Fixed) Adds port as a static entry. GVRP protocol messages are still forwarded through this port. X : (Forbidden) Disables GVRP for this VLAN on the specified port. If a removed port is no longer assigned to any other group as an untagged port, it will automatically be assigned to VLAN group 1 as untagged.

NOTE: Use the <Next Page> and <Prev Page> buttons to scroll through the table. To display a specific page, set the page number in the Page field and press <Apply>. To modify a VLAN group, highlight the entry in the table and press Enter. To add a VLAN group, press <Add>.

The VLAN Table Configuration of WGS3-404 is as the following:

```

VLAN Menu: VLAN Table Configuration
=====

VLAN      MEMBERS      UNTAG
 1         12345678     12345678
           SSSSSSSS  UUUUUUUU

-: Normal
S: Static
R: Reg. Fixed
X: Forbidden

U: Untag
T: Tag

Page : 1 <Apply>          Total: 1 Pages
<OK>   <Prev Page>   <Next Page>   <Add>
Enter page number than press 'Apply' to see VLAN group. | READ/WRITE
Use <TAB> or arrow keys to move, other keys to make changes.

```

Parameter	Description
VLAN	The ID for the VLAN currently displayed. Range: 1-4094
MEMBERS	Port entries may be marked as: - : (Normal) Uses GVRP to determine port membership. S : (Static) Adds port as a static entry. GVRP protocol is disabled. R : (Registration Fixed) Adds port as a static entry. GVRP protocol messages are still forwarded through this port. X : (Forbidden) Disables GVRP for this VLAN on the specified port. If a removed port is no longer assigned to any other group as an untagged port, it will automatically be assigned to VLAN group 1 as untagged.
UNTAG	Specify the outbound packets for this VLAN on this port should be tagged or untagged. U: The outbound packets for this VLAN on this port should be untagged. T: The outbound packets for this VLAN on this port should be tagged.

4.5.4.3 Reset Address Table Mode

WGS3-404 provide two address table modes, SVL (Shared VLAN Learning) and IVL (Independent VLAN Learning).

SVL: Configuration and operation of the MAC address learning process with the same MAC address table for all VLANs. If an individual MAC Address is learned in one VLAN, that learned information is used in forwarding decisions taken for that address relative to all other VLANs. SVL is suitable when you need to have asymmetric VLANs. Under normal circumstances, a pair of devices communicating in a VLAN environment will both send and receive using the same VLAN. However, there are some circumstances in which it is convenient to make use of two distinct VLANs, one used for A to transmit to B: the other used for B to transmit to A.

IVL: Configuration and operation of the MAC address learning process with difference MAC address table for all VLANs. If a given individual MAC Address is learned in one VLAN, that learned information is not used in forwarding decisions taken for that address relative to any other VLAN. IVL is suitable when two or more VLANs are connected by a bridge(switch) or there are duplicate MAC addresses on different VLANs.

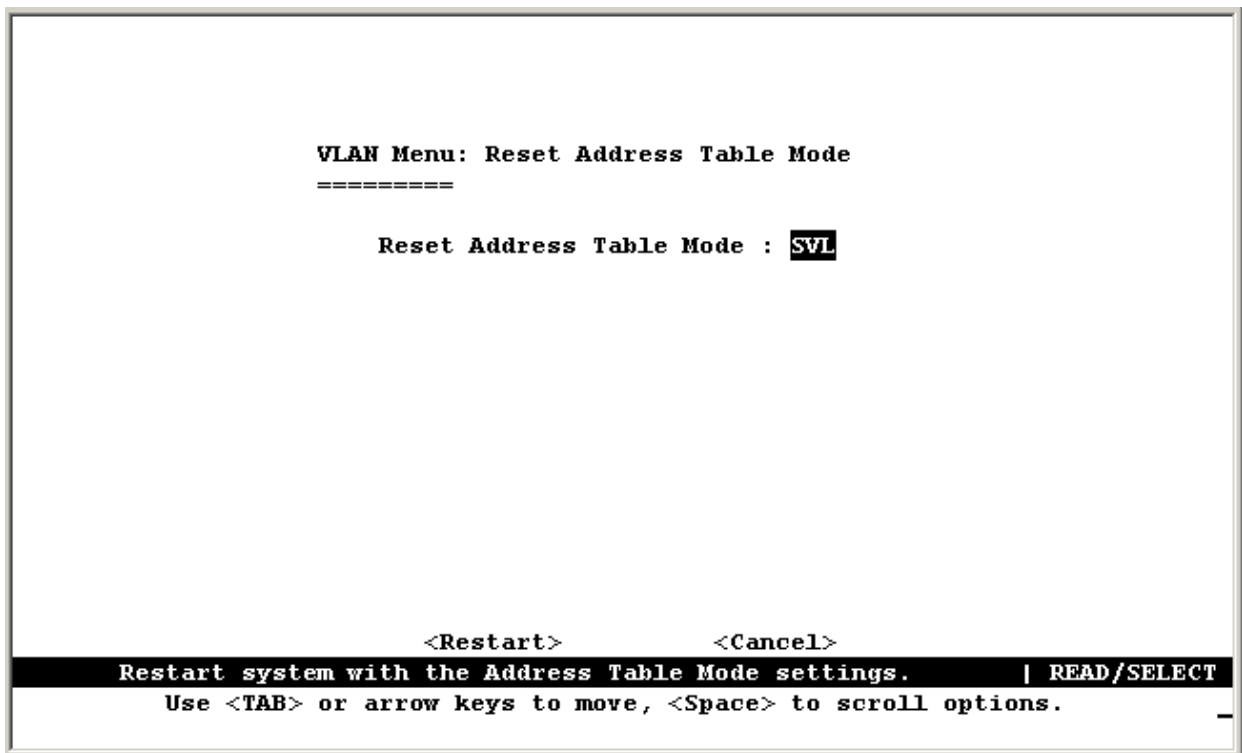

Parameter	Default	Description
Reset Address Table Mode	SVL	Specify the address table mode to be SVL or IVL.

4.5.5 Configuring IGMP Snooping

This option is displayed on Device Control Menu for Layer 2 mode of WGS3-2620 and on Protocol Configuration Menu (under Device Control Menu -> IP Menu) for Layer 3 mode of WGS3-2620 or WGS3-404. Multicasting is used to support real-time applications such as video conferencing or streaming audio. A multicast server does not have to establish a separate connection with each client. It merely broadcasts its service to the network; and any hosts which want to receive the multicast register with their local multicast switch/router. Although this approach reduces the network overhead required by a multicast server, the broadcast traffic must be carefully pruned at every multicast switch/router it passes through to ensure that traffic is only passed on to the hosts which subscribed to this service.

This switch uses IGMP (Internet Group Management Protocol) Snooping to monitor any attached hosts which want to receive a specific multicast service. It looks up the IP Multicast Group used for this service, and adds any port which received a similar request to that group.

You can use the IGMP Snooping Configuration screen to configure multicast filtering shown below.

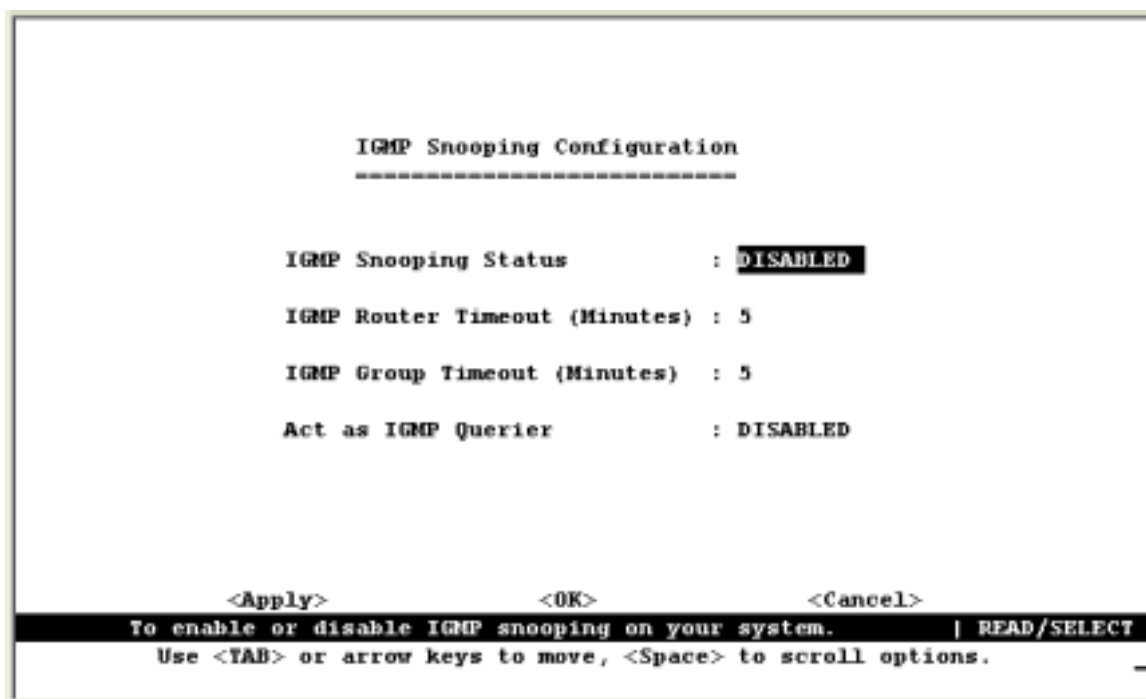

Parameter	Default	Description
IGMP Snooping Status ^{*1}	Disabled	If enabled, the switch will monitor network traffic to determine which hosts want to receive multicast traffic. This is also referred to as IGMP Snooping.
IGMP Router Timeout	5	A switch port that stops receiving multicast protocol packets for this interval will be removed from the IGMP forwarding list. Range: 3 - 5 minutes
IGMP Group Timeout	5	The time between last spotting an IGMP Report message for an IP multicast address on a specific port and the switch removing that entry from its list. Range: 3 - 5 minutes
Act as IGMP Querier ^{*2}	Disabled	If enabled, the switch can serve as the “querier,” which is responsible for asking hosts if they want to receive multicast traffic.

1: This item is only displayed for Layer 2 mode of WGS3-2620. For WGS3-404 and multilayer mode of WGS3-2620, the full IGMP protocol set is automatically enabled/disabled along with DVMRP. (See “6.4 Multicast Filtering” and “4.5.6.1.5 Configuring DVMRP”.)

2: This item is only displayed for Layer 2 mode of WGS3-2620. When IGMP is enabled for WGS3-404 and multilayer mode of WGS3-2620, the switch will always serve as the querier if elected.

4.5.6 Configuring IP Settings

If this switch is WGS3-404 or WGS3-2620 in multilayer mode(see

4.5.1 Setting the System Operation Mode), the IP Menu will be displayed. Use this menu to configure the IP subnets for each VLAN on your switch, the unicast and multicast routing protocols, static ARP entries, static IP routes, and the default IP Route.



Parameter	Description
Subnet Configuration	Specifies the IP interface for VLANs configured on this switch, including the subnet address and routing Protocols
Protocol Configuration	Configures ARP timeout, enables Proxy ARP, sets the preferred servers for BOOTP/DHCP Relay, as well as enabling/configuring unicast and multicast protocols globally for this switch.
Static ARP Configuration	Used to map an IP address to a specific physical MAC address
Static Route	Used to configure static routes to other IP networks, subnetworks, or hosts.
Default Route	Defines the router to which this switch will forward all traffic for unknown networks.

4.5.6.1 Subnet Configuration

Use this menu to specify an IP interface for any VLAN configured on this switch that needs to communicate with a device outside of its own group (that is, another network segment). You also need to define a VLAN for each IP subnet connected directly to this switch. Note that you must first create a VLAN as described under “Configuring Virtual LANs” before configuring the corresponding subnet. If you need to manage the switch in-band then you must define the IP subnet address for at least one VLAN.

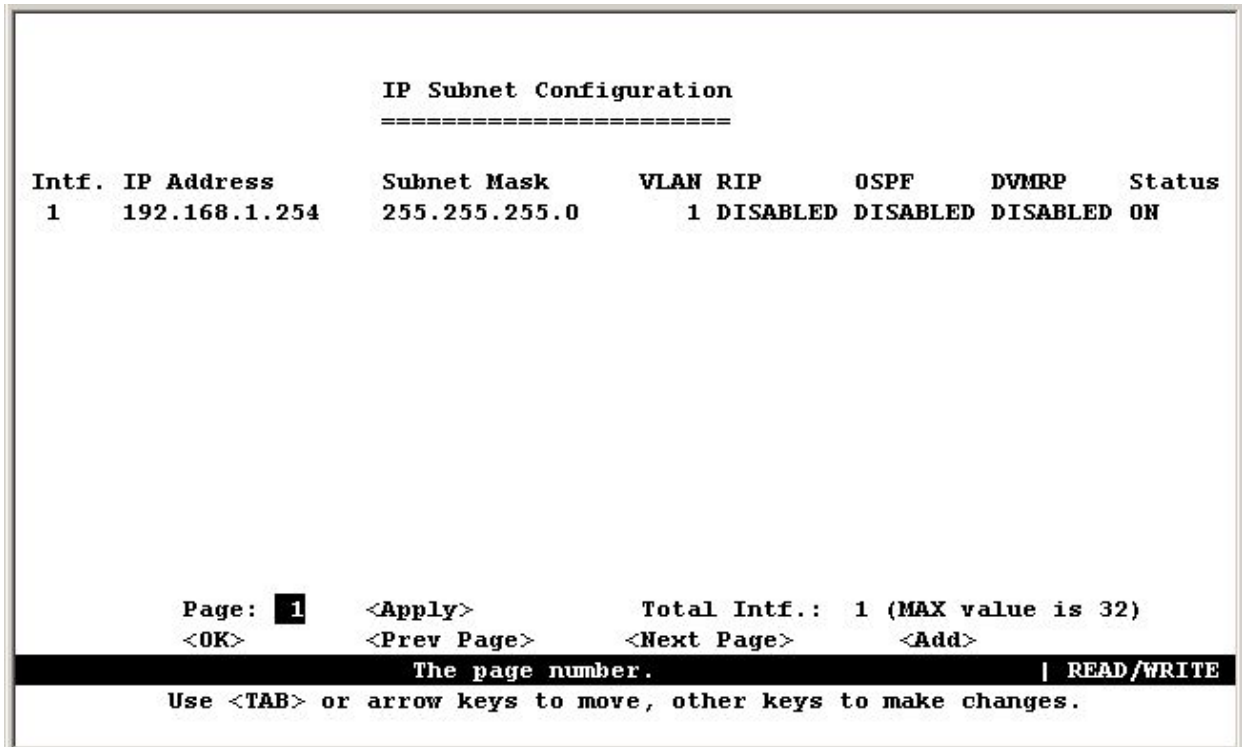

Parameter	Description
IP Address	The IP address associated with the specified VLAN interface. In general, it is the router IP address for the specified VLAN members.
Subnet Mask	A template that identifies the address bits in the host address used for routing to specific subnets. Each bit that corresponds to a “1” is part of the network / subnet number; and each bit that corresponds to “0” is part of the host number.
VLAN	The VLAN associated with this IP interface.
RIP	Routing Information Protocol for unicast routing.
OSPF	Open Shortest Path First unicast routing protocol.
DVMRP	Distance-Vector Multicast Routing Protocol.

NOTE: Use the <Next Page> and <Prev Page> buttons to scroll through the subnet configuration table. To display a specific page, set the page number in the Page field and then press <Apply>. To modify an IP interface, highlight the entry in the table and press Enter. To add an IP interface, press <Add>.

4.5.6.1.1 Adding an IP Interface

Select <Add> on the Subnet Configuration menu to add an IP interface. When the Add Subnet screen opens as shown below, assign a VLAN group to this interface, configure the IP address, and then enable the required routing protocols. You can specify a VLAN that has already been configured on this switch or press "Select" to open the Port Group Configuration screen and create or modify a VLAN group.

To configure the unicast or multicast routing protocols, select the IP address for a specific interface from the Subnet Configuration menu, and then select "Advanced" configuration from the Modify Subnet screen.

```

Add Subnet
=====

VLAN      : 1          Select VLAN

IP Address : 0.0.0.0
Subnet Mask : 255.255.255.0

Proxy ARP  : DISABLED
RIP        : DISABLED
OSPF       : DISABLED
DVMRP      : DISABLED

<OK>                      <Cancel>
Please enter VLAN ID.      | READ/WRITE
Use <TAB> or arrow keys to move, other keys to make changes.
```

Parameter	Description
VLAN	The VLAN associated with this IP interface.
Select	Use this option to create or modify a VLAN under the “Port Group Configuration” menu.
IP Address	The IP address associated with the specified VLAN interface. In general, it is the router IP address for the specified VLAN members.
Subnet Mask	A template that identifies the address bits in the host address used for routing to specific subnets. Each bit that corresponds to a “1” is part of the network / subnet number; and each bit that corresponds to “0” is part of the host number.
Proxy ARP	<p>Enables or disables Proxy ARP for the interface. This feature allows the switch forward an ARP request from a node in the attached subnetwork (that does not have routing or a default gateway configured) to a remote subnetwork. (See “6.2.5 Proxy ARP”.)</p> <p>Note that Proxy ARP must be enabled globally for the switch before this setting can take effect. (See “4.5.6.2 Protocol Configuration”.)</p>
RIP	Routing Information Protocol for unicast routing.
OSPF	Open Shortest Path First unicast routing protocol.
DVMRP	Distance-Vector Multicast Routing Protocol.

4.5.6.1.2 Configuring Port Groups

You can create a new VLAN group or modify the members of an existing group by pressing “Select” on the Add Subnet screen.

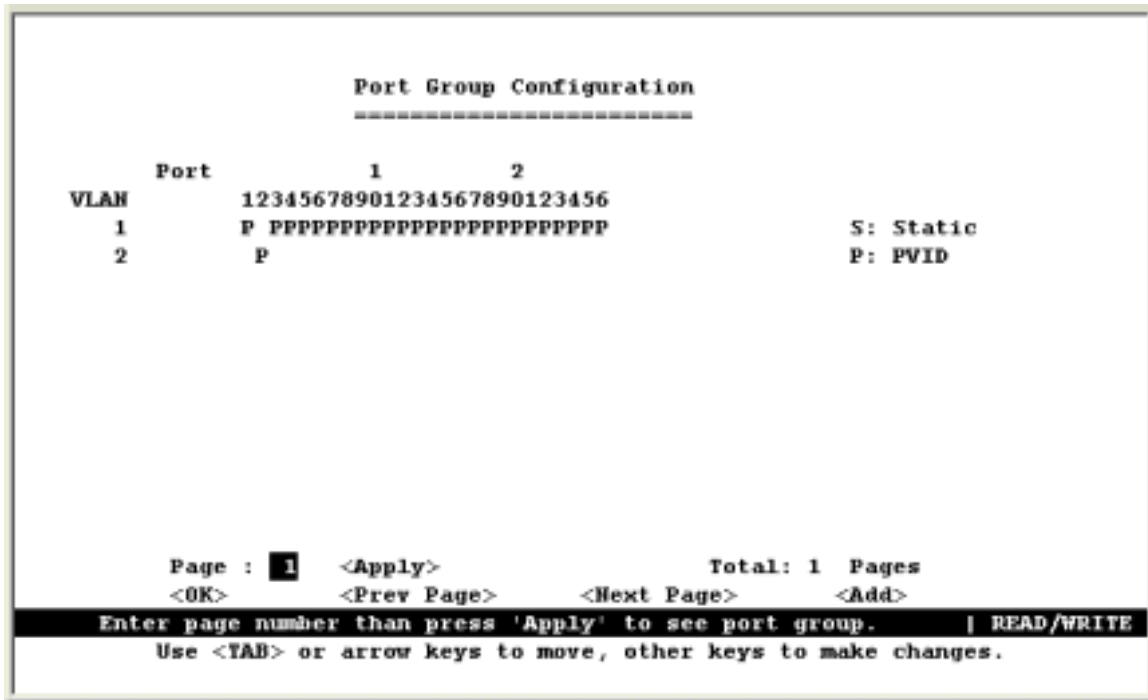

Parameter	Description
VLAN	A VLAN already configured on this switch.
Port	Port entries may be marked as: S : Adds port as a static entry. P : Adds port as a static entry, and sets the port' s PVID to this VLAN ID.

NOTE: Use the <Next Page> and <Prev Page> buttons to scroll through the table. To display a specific page, set the page number in the Page field and then press <Apply>. To modify a VLAN, highlight the entry in the table and press Enter. To add a new VLAN, press <Add>.

4.5.6.1.3 Modifying an IP Interface

To modify an IP interface, first highlight the IP address in the Subnet Configuration menu, and then press Enter. The Modify Subnet screen is nearly the same as the Add Subnet screen. However, it also includes an “Advanced” option that allows you to configure the unicast and multicast routing protocols as described in the following sections.

```

Modify Subnet
=====

VLAN:      1          Select

IP Address: 10.0.0.254
Subnet Mask: 255.0.0.0

Proxy ARP   : DISABLED
RIP         : DISABLED   Advanced ...
OSPF        : DISABLED   Advanced ...
DVMRP       : DISABLED   Advanced ...

<Delete>   <Apply>       <OK>       <Cancel>
VLAN ID.   | READ/WRITE

Use <TAB> or arrow keys to move, other keys to make changes.
```

4.5.6.1.4 Configuring RIP

The Routing Information Protocol is used to specify how routers exchange routing table information. (See “RIP and RIP-2 Dynamic Routing Protocols” on Chapter “Advanced Topics”.) When RIP is enabled on this routing switch, it broadcasts RIP messages to all devices in the network every 30 seconds, and updates its own routing table when RIP messages are received from other routers. RIP messages contain both the IP address and a metric for each destination network it knows about, where the metric indicates the number of hops from this device to the destination network.

You can use the following menu to specify authentication, the protocol used for sending or receiving routing messages on this port, the default metric used in calculating the best path, and enable or disable Poison Reverse.

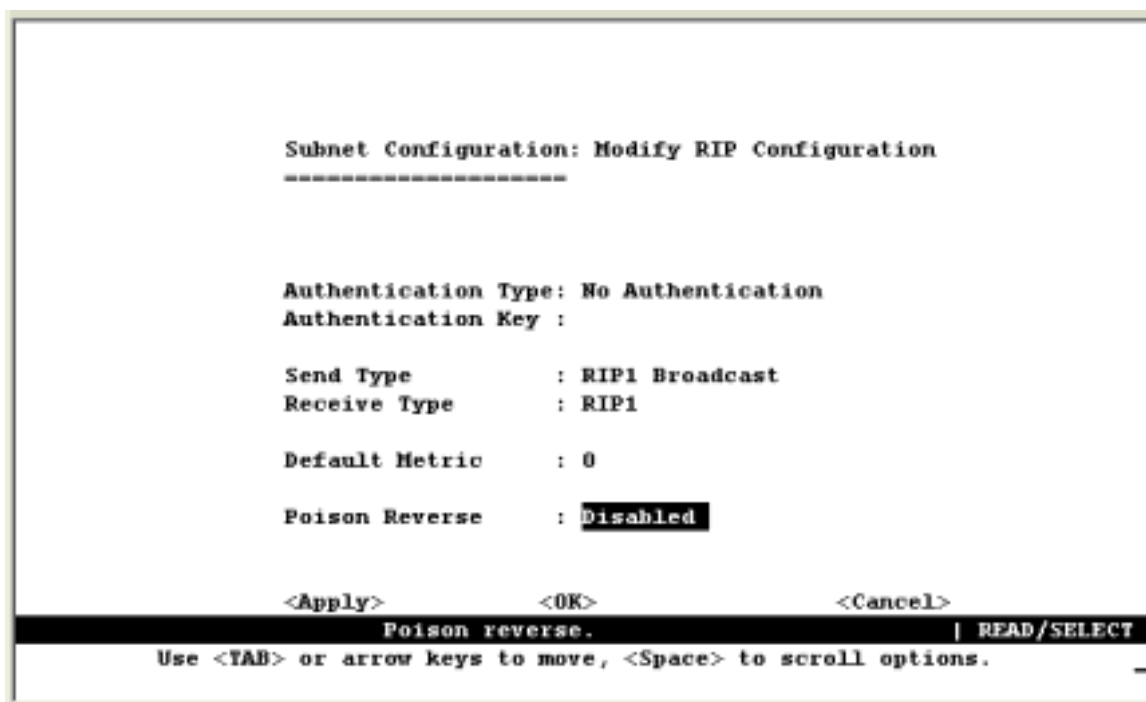

Parameter	Description
Authentication Type	Authentication can be used to ensure that routing information comes from a valid source.
Authentication Key	A simple password must be provided if authentication is enabled. (An authentication string is case sensitive, and can be up to 16 characters.)
Send Type	The protocol used for traffic sent out this port: RIP1 Broadcast— Route information is broadcast to other routers on the network using RIPv1. RIP2 Broadcast— Route information is broadcast to other routers on the network using RIPv2. RIP2 Multicast— Route information is multicast to other routers on the network using RIPv2. Do Not Send— The switch will passively monitor route information advertised by other routers attached to the network.
Receive Type	The routing protocol messages accepted on this port includes RIP1, RIP2, RIP1/RIP2, or Disabled (i.e., none received).
Default Metric	A “metric” indicates the number of hops between the switch and the destination network. The “default metric” is used for the default route in RIP updates originated on this interface. A value of zero indicates that no default route should be originated; in this case, a default route via another router may be propagated. Range: 0-15
Poison Reverse*	Propagates routes back to an interface port from which they have been acquired, but sets the distance vector metrics to infinity.

NOTE: This is a method of preventing routing information from looping back to the source. Note that Split Horizon is also enabled on this switch for this purpose. (See “6.2.6.1 RIP and RIP-2 Dynamic Routing Protocols”.)

4.5.6.1.5 Configuring OSPF

Open Shortest Path First is more suited for large area networks which experience frequent changes in the links. It also allows for subnets. This protocol actively tests the status of each link to its neighbors to generate a shortest path tree, and builds a routing table based on this information. OSPF then utilizes IP multicast to propagate routing information. A separate routing area scheme is also used to further reduce the amount of routing traffic. You can use the following menu to specify the area identifier, or other key routing parameters as described in the following table.

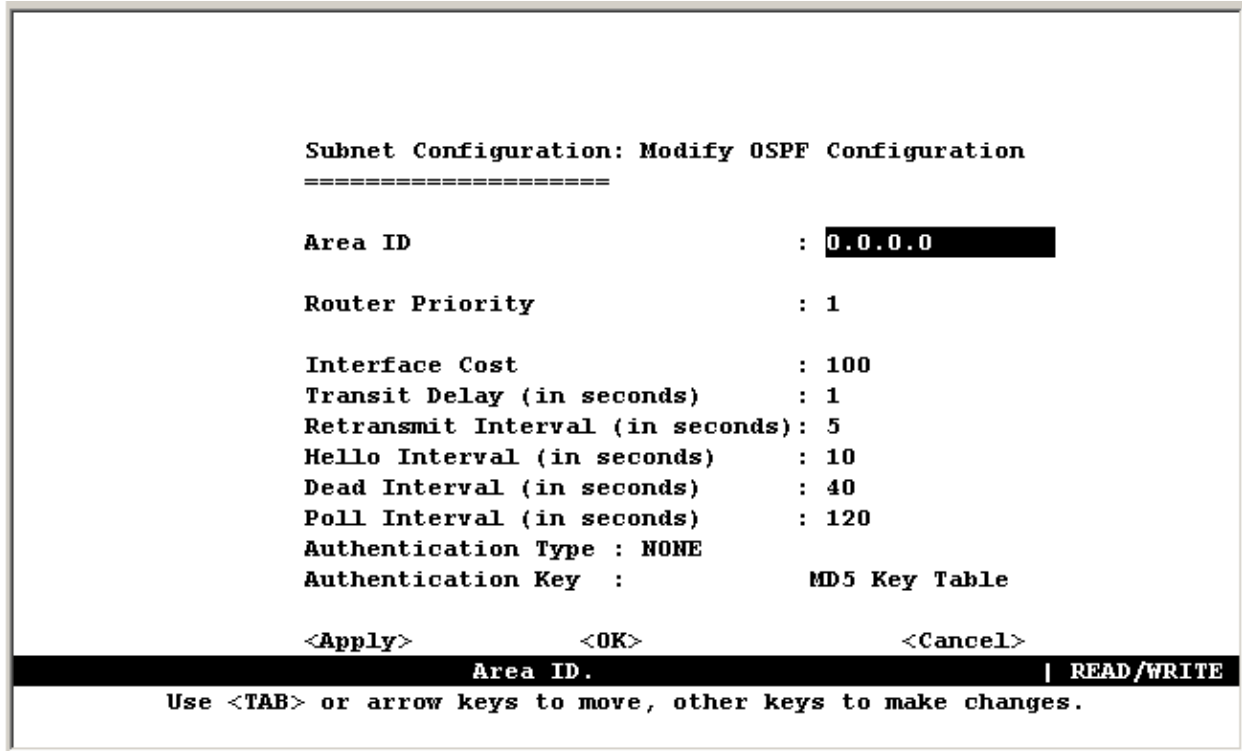

Parameter	Default	Description
Area ID ¹	0.0.0.0	A 32-bit integer uniquely identifying an OSPF protocol broadcast area. This identifier can be in the form of an IP address or integer. Each port on the switch can be configured to represent one OSPF area. You must first specify OSPF areas for global access in the Area ID Configuration menu, before they can be used for a specific IP interface. ID 0.0.0.0 is used for the OSPF backbone.
Router Priority	1	The priority used when selecting the designated router and designated backup router. Range: 0-255; Disable election: 0
Interface Cost	100	Explicitly specify the cost of sending a packet on the interface. Range: 1-65535

Transit Delay	1 second	<p>The estimated number of seconds it takes to transmit a link state update packet over this interface.</p> <p>Range: 0-3600 seconds</p>
Retransmit Interval	5 seconds	<p>The number of seconds between retransmitting link-state advertisements to router adjacencies on this interface. This value is also used when retransmitting database descriptions and link-state request packets.</p> <p>Range: 0-3600 seconds</p>
Hello Interval ^{*2}	10 seconds	<p>The interval, in seconds, between sending Hello packets out the router interface. This interval determines how fast topology changes will be detected. However, for small intervals, more overhead will be incurred in exchanging routing information.</p> <p>Range: 1-65535 seconds</p>
Dead Interval ^{*2}	40 seconds	<p>The number of seconds that a router's Hello packets have not been seen before its neighbors declare the router down. This should be a multiple of the Hello interval.</p> <p>Range: 1-65535 seconds</p>
Poll Interval	120 seconds	<p>Sets the poll interval (in seconds) for this interface. If a neighboring router has become inactive (Hello Packets have not been seen for Router Dead Interval), then it may still be necessary to send Hello Packets to the dead neighbor. These Hello Packets are sent at the reduced rate which should be much larger than Hello Interval. The default is 120 seconds.</p>
Authentication Type NONE		<p>Use this option to specify how to authenticate neighboring OSPF routers. There are three options:</p> <p>NONE: Not to authenticate neighboring routers.</p> <p>SIMPLE: Use password to authenticate neighboring OSPF routers. The password is assigned on Authentication Key field. With SIMPLE authentication, the password goes in clear-text over the network. Thus, anyone with a sniffer software on the OSPF network segment would be able to pull the OSPF password, and the network attacker would be one step closer to compromising your OSPF environment.</p> <p>MD5: Use MD5 to authenticate neighboring routers. With MD5 authentication, the key does not pass over the network. MD5 is a message-digest algorithm specified in RFC1321. MD5 should be considered the most secure OSPF authentication mode. You have to specify an active MD5 key on MD5 Key Table.</p>
Authentication Key		<p>When use SIMPLE authentication type, enter the password here. The password can be any string of keyboard-entered characters up to 8 bytes in length. All neighboring routers on the same network must have the same password to exchange OSPF information.</p>

MD5 Key Table

When use MD5 authentication mode, you have to specify an active MD5 key on this table. Up to 8 key can be added on the table but only one can be **Active**. The others should be left to be **Valid**. To remove the key, set the status to be **Invalid** and select <Apply>. Each key consists of two parameters:

Key ID : An identifier from 1 to 255.

Key : An alphanumeric password of up to 16 bytes.

1: The Area ID is used to specify a group of contiguous networks and hosts. OSPF protocol broadcast messages are restricted by area to limit their impact on network performance.

2: This value must be the same for all routers attached to a common network.

4.5.6.1.6 Configuring DVMRP

Distance Vector Multicast Routing Protocol is used to route multicast traffic to nodes which have requested a specific multicast service via IGMP. (See "6.4.4 DVMRP Routing Protocol") To configure DVMRP, you must specify the routing metric, probe interval, and neighbor router timeout.

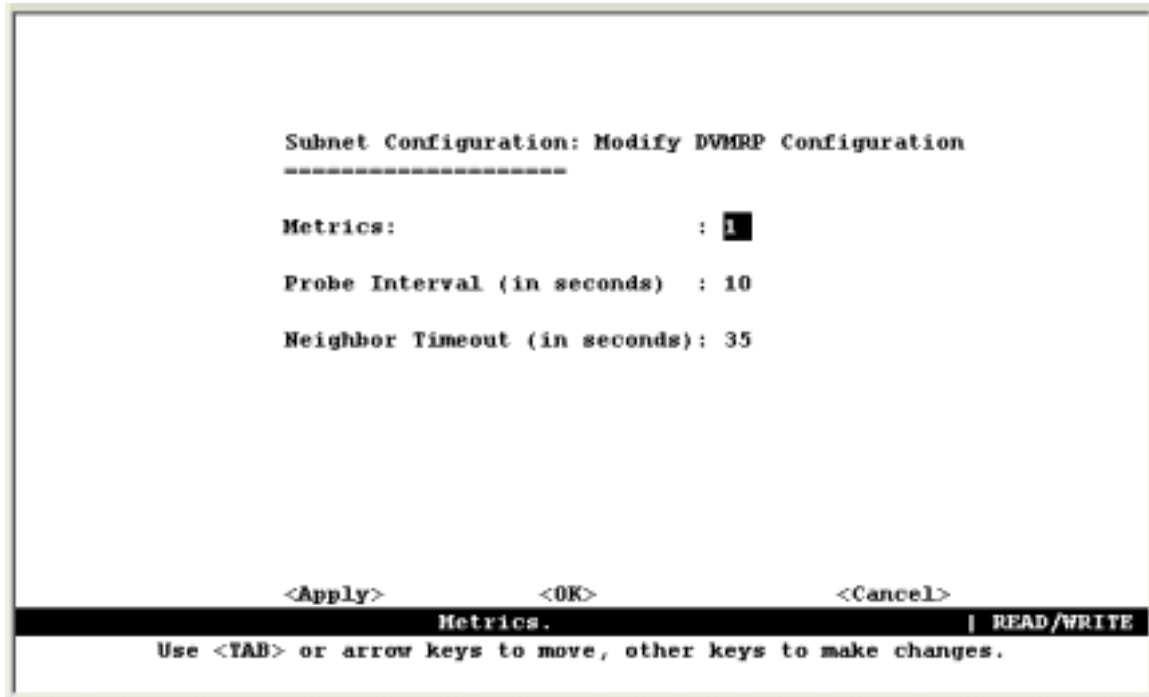

Parameter	Default	Description
Metrics	1 hop	This value is used to select the best reverse path to networks that are connected directly to an interface on this switch. Range: 1-31 hops
Probe Interval	10 seconds	The interval between sending neighbor probe messages to the multicast group address for all DVMRP routers. Range: 5-30 seconds
Neighbor Timeout	35 seconds	The interval to wait without hearing from a DVMRP neighbor before declaring it dead. This is used for timing out routes, and for setting the children and leaf flags. Range: 10-8000 seconds

NOTE: IGMP is automatically enabled/disabled along with DVMRP. (See "6.4.2 IGMP Protocol".)

4.5.6.2 Protocol Configuration

Use the Protocol Configuration screen to globally enable or disable unicast or multicast routing protocols for the switch.

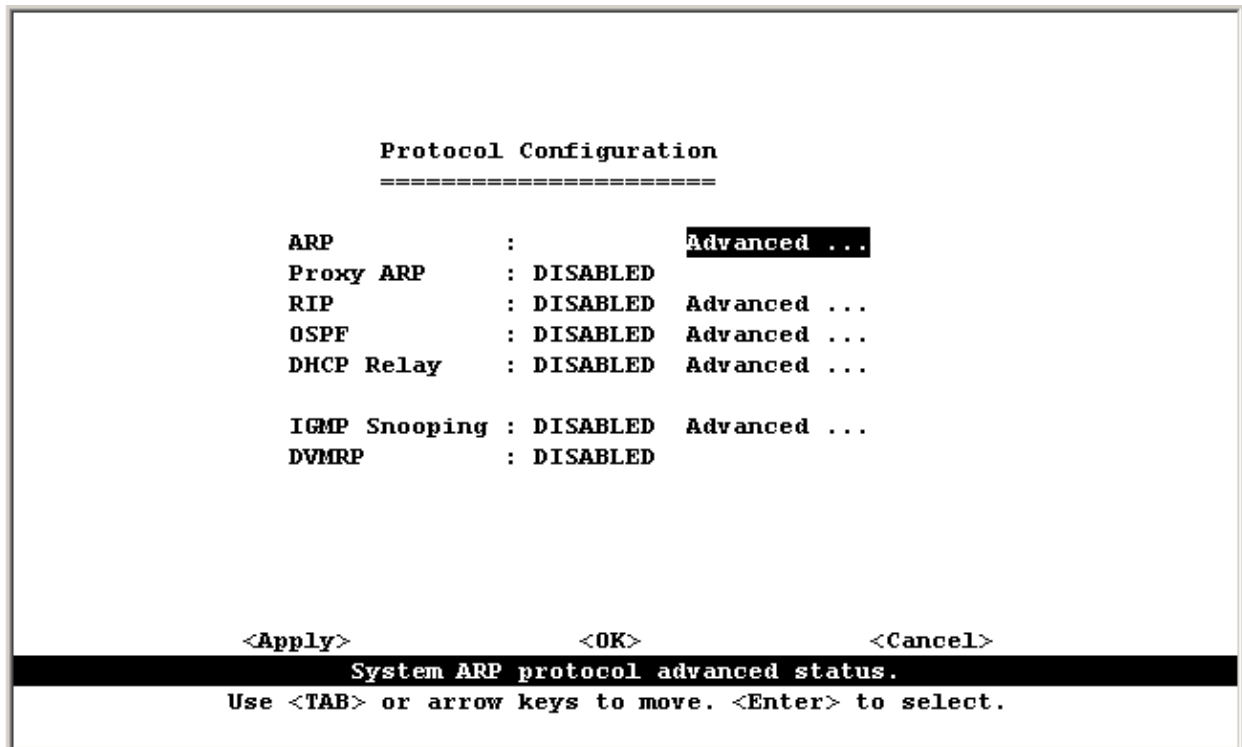

Parameter	Description
ARP	Sets the aging time for dynamic ARP entries.
Proxy ARP	<p>Enables or disables Proxy ARP globally for the switch. This feature allows the switch to forward an ARP request from a node in the attached subnetwork (that does not have routing or a default gateway configured) to a remote subnetwork. (See “6.2.5 Proxy ARP”).</p> <p>If Proxy ARP is globally enabled for the switch, then you can enable or disable it for a specific interface. See “4.5.6.1.1 Adding an IP Interface”, or “4.5.6.1.3 Modifying an IP Interface”.</p>
RIP	Enables or disables the Routing Information Protocol. The Advanced menu sets the interval at which the switch advertises known routes, and also enables/disables advertising for static routes or the default route.
OSPF	Enables or disables the OSPF routing protocol. The Advanced menu organizes an autonomous system into normal, stub, or not so stubby areas; configures a range of subnet addresses for which link state advertisements can be aggregated; and configures virtual links for areas that do not have direct physical access to the OSFP backbone, to add redundancy, or to merge backbone areas.
DHCP Relay	Enables or disables BOOTP/DHCP Relay. The Advanced menu defines the preferred servers or the outbound subnetworks for broadcasting a BOOTP/DHCP

	request.
IGMP Snooping	Enables or disables IGMP Snooping. The Advanced menu sets the timeout for inactive multicast ports or for specific multicast flows when there are no longer any clients.
DVMRP	Enables or disables the Distance-Vector Multicast Routing Protocol.

NOTE: Once RIP and DVMRP have been globally enabled, you can enable or disable them for any specific subnet via the Subnet Configuration menu.

4.5.6.2.1 Setting the ARP Timeout

You can use the following configuration screen to modify the aging time for dynamically learned entries in the ARP cache.

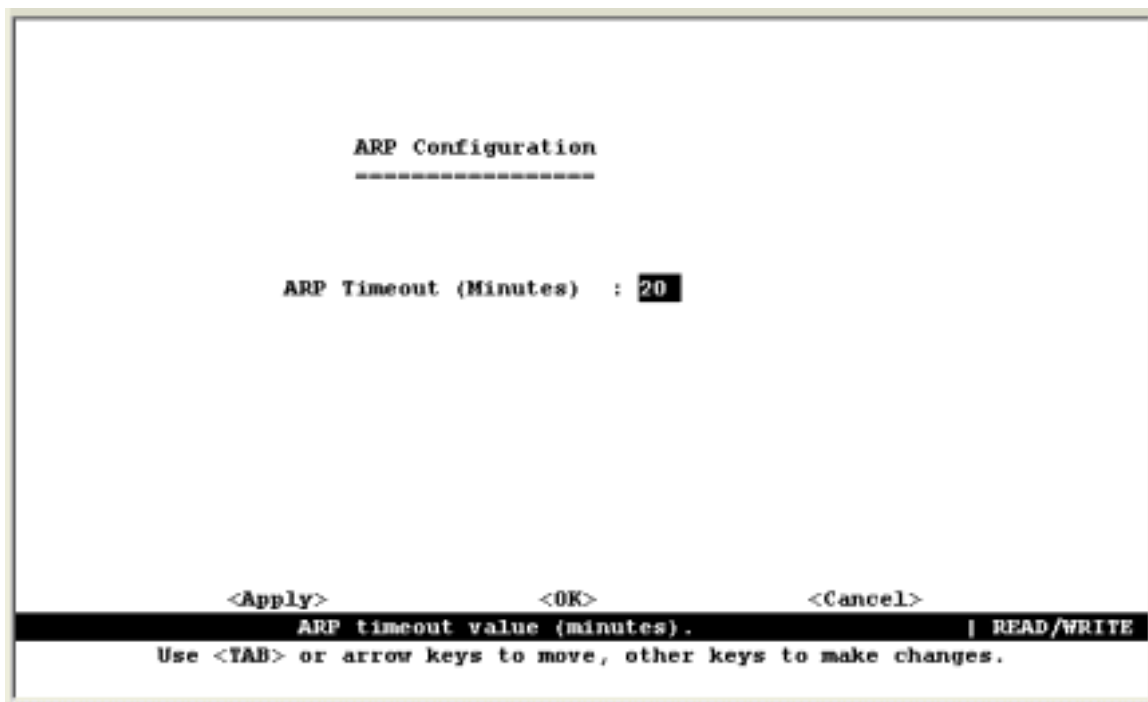

Parameter	Default	Description
ARP Timeout	20 minutes	The time that dynamically learned entries are retained in the ARP cache. Range: 0-999 minutes, where 0 disables aging

4.5.6.2.2 Setting the RIP Advertisement Policy

You can use the following configuration screen to set the timing interval and policies RIP uses to advertise route information.

```
RIP Configuration
*****

RIP Update Time (Seconds) : 30
Default Route Advertisement : DISABLED
Static Route Advertisement : DISABLED
Ignore Host Route         : DISABLED

<Apply>          <OK>          <Cancel>
RIP timeout value {seconds}. | READ/WRITE
Use <TAB> or arrow keys to move, other keys to make changes.
```

Parameter	Default	Description
RIP Update Time	30 seconds	The interval at which RIP advertises known route information. Range: 0-999 seconds, where 0 disables route advertisements
Default Route Advertisement	Disabled	Enables or disables advertising this switch as a default router.
Static Route Advertisement	Disabled	Enables or disables advertisement of static routes.
Ignore Host Route	Disabled	If enabled, the switch will not import a default route from other routers.

4.5.6.2.3 Configuring Global Settings for OSPF

To implement OSPF for a large network, you must first organize the network into logical areas to limit the number of OSPF routers that actively exchange Link State Advertisements (LSAs). You can then define an OSPF interface by assigning an IP interface configured on this switch to one of these groups. This OSPF interface will send and receive OSPF traffic to neighboring OSPF routers. You can further optimize the exchange of OSPF traffic by specifying an area range that covers a large number of subnetwork addresses. This is an important technique for limiting the amount of traffic exchanged between Area Border Routers (ABRs). And finally, you must specify a virtual link to any OSPF area that is not physically attached to the OSPF backbone. Virtual links can also be used to provide a redundant link between contiguous areas to prevent areas from being partitioned, or to merge backbone areas.

The following menu provides all the global configuration options for OSPF:

```
OSPF Configuration Menu
=====

Router ID Selection : STATIC INTE
Router Id : 10.0.0.254
AS Border Status : Disabled
RFC 1583 Compatibility : Disabled

Area ID Configuration ...
OSPF Area Range Configuration ...
OSPF Virtual Link Configuration ...
OSPF Host Route Configuration ...

<Apply>           <OK>           <Cancel>
System router ID automatic configuration status. | READ/SELECT
Use <TAB> or arrow keys to move, <Space> to scroll options.
```

Parameter	Default	Description
Router ID Selection	STATIC INTF	Defines how the Router ID is determined: There are three options: STATIC: User can manual configure the Router ID. STATIC INTF: The VLAN 1 IP address will be used as Router ID ACTIVE INTF: The first active interface will be used as Router ID
Router ID	VLAN 1 IP	A 32-bit number assigned to each router running the OSPF protocol. This number uniquely identifies the router within an Autonomous System.
RFC 1583 Compatibility	Disabled	Enable or disable the compatibility to RFC 1583 OSPF version 2
Area ID Configuration		Defines an area within which all OSPF routers actively exchange routing information to ensure that they all have an identical link state database.
OSPF Area Range Configuration		Defines a range of subnetwork addresses. An area range is used to summarize route information exchanged between Area Border Routers.
OSPF Virtual Link Configuration		Defines a virtual link that can be used to connect an OSPF area not physically adjacent to the OSPF backbone, or to create a backup link to any area.

Parameter	Description
Area ID	An OSPF area identifier configured for a group of OSPF routers. (For information on how to assign this identifier to a specific interface, see 4.5.6.1.5 Configuring OSPF.)
Type	Indicates area type: Normal – An area which can send or receive external route information. Stub – An area which cannot send or receive external route information. It relies on a single default route provided by its Area Border Router (ABR) to access destinations outside of the stub. A stub can be used to reduce the amount of topology data that has to be exchanged over the network. NSSA – A not so stubby area cannot send but can receive external route information. The ABR imports external routes and floods this information to all routers within the NSSA.

An Autonomous System Boundary Router (ASBR) can import external routes and flood this information to the entire Autonomous System.

NOTE: To add a new Area ID, use the <Add> button. (The default 0.0.0.0 indicates the OSPF backbone.) To modify or delete an existing Area ID, highlight the table entry with the cursor and select Enter.

4.5.6.2.3.2 OSPF Area Range Configuration

After you configure an area identifier, you can specify a subnetwork address range that covers all the individual networks in this area. This technique limits the amount of traffic exchanged between Area Border Routers (ABRs) by allowing them to advertise a single summary range. By summarizing routes, the routing changes within an area do not have to be updated in the backbone ABRs or in other areas.

To optimize the route summary, first configure all the OSPF routers in an area so that they fall within a contiguous address range. The route summary consists of an address and mask, where the mask can be a Variable Length Subnet Mask (VLSM). Using VLSMs allows you to configure each subnetwork within a larger network with its own subnet mask. This provides a longer subnet mask that covers fewer host IP addresses, thereby reducing the size of the routing tables that have to be exchanged. (For more information on VLSMs, see RFCs 1219 and 1878.)

```

                                OSPF Area Range Configuration
                                =====

Area Identity  IP Address  Address Mask  Advertisement
192.168.2.0   192.168.2.0  255.255.255.0  Advertise
192.168.4.0   192.168.4.0  255.255.255.0  Advertise

Page : 1  <Apply>                               Total : 1 pages
<OK>    <Prev Page>   <Next Page>   <Add>
Add OSPF area entry.
Use <TAB> or arrow keys to move. <Enter> to select.

```

Parameter	Description
Area Identity	An OSPF area that includes all the OSPF routers within the assigned address range
IP Address	The IP address used to calculate the area range.
Address Mask	The subnet mask used to calculate the area range.
Advertisement	Enables or disables advertising for this range.

NOTE: To add a new OSPF Area Range, use the <Add> button. To delete an existing range, highlight the table entry with the cursor and select Enter.

4.5.6.2.3.3 OSPF Virtual Link Configuration

All OSPF areas must connect to the backbone. If an area does not have a direct physical connection to the backbone, you can configure a virtual link that provides a logical path to the backbone. To connect an isolated area to the backbone, the logical path can cross a single nonbackbone area to reach the backbone. To define the path, you must specify one endpoint on the ABR that connects the isolated area to the common nonbackbone area, and the other endpoint on the ABR that connects this common nonbackbone area and the backbone itself. (However, note that you cannot configure a virtual link that runs through a stub or NSSA area.)

Virtual links can also be used to create a redundant link between any area and the backbone to help prevent partitioning, or to connect two existing backbone areas into a common backbone.

To configure a virtual link, specify the transit area through which the endpoint routers connect, and the address of the router on this side of the link.

```

                                OSPF Virtual Link Configuration
                                =====
Area ID      Neighbor Router ID  Status
192.168.3.0  192.168.3.254     Down

Page : 1  <Apply>                Total : 1 pages
<OK>    <Prev Page>    <Next Page>    <Add>
Add OSPF area entry.
Use <TAB> or arrow keys to move. <Enter> to select.
```

Parameter	Description
Area ID	An identifier for the transit area the virtual link crosses
Neighbor IP	The IP address of the OSPF router on this end of the virtual link.

Modifying a Virtual Link –

You can modify or delete a virtual link by selecting the required entry in the table with your cursor and pressing Enter. The screen will display configuration options as shown in the following example.

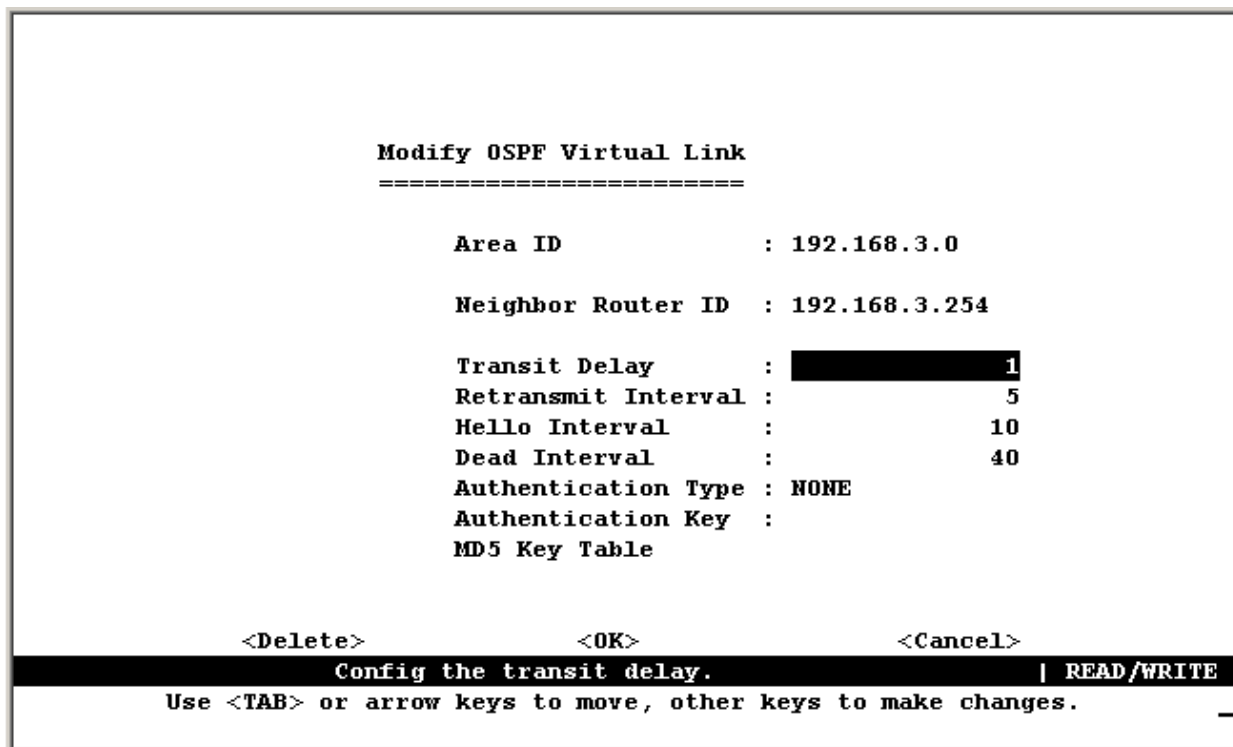

Parameter	Default	Description
Area ID		An identifier for the transit area the virtual link crosses.
Neighbor IP		The IP address of the OSPF router on this end of the virtual link.
Transit Delay	1 second	The estimated number of seconds it takes to transmit a link state update packet over this virtual link. Range: 0-3600 seconds
Retransmit Interval	5 seconds	The number of seconds between retransmitting link-state advertisements to the router at the other end on the virtual link. This value is also used when retransmitting database descriptions and link-state request packets. Range: 0-3600 seconds
Hello Interval ²	10 seconds	The interval, in seconds, between sending Hello packets out the router interface. Range: 1-65535 seconds
Dead Interval ²	40 seconds	The number of seconds that a router's Hello packets have not been seen before the router at the other end of the virtual link is declared down. This should be a multiple of the Hello interval. Range: 1-65535 seconds
Authentication Type	None	Authentication can be used to ensure that routing information comes from a valid source. The options include none or a simple password.
Authentication Key		A simple password must be provided if authentication is enabled. (An authentication string is case sensitive, and can be up to 16 characters.)

4.5.6.2.4 Configuring DHCP Relay

If a DHCP server is not located in the same subnet with a host, you can configure this switch to forward any host configuration queries to a server located on another subnet or on another network. Depending on the configuration setup, the switch either:

- Forwards the packet to a preferred server as defined in the switch configuration using unicast routing, or
- Broadcasts the DHCP Request again to another directly attached IP subnet specified in the switch configuration.

Specify the address for any DHCP server, or specify the subnet address for an outbound IP interface already configured on this switch as described in the following screens.



Parameter	Description
Index Server Address	Used to define any preferred DHCP servers or the outbound subnetwork for relaying a DHCP request broadcast. (Up to five entries are permitted.)

4.5.6.3 Static ARP Configuration

Use the following screen to display or edit entries in the Static ARP Table. Entries added to this table are retained until the associated IP interface is deleted or the switch is reset to the factory defaults.

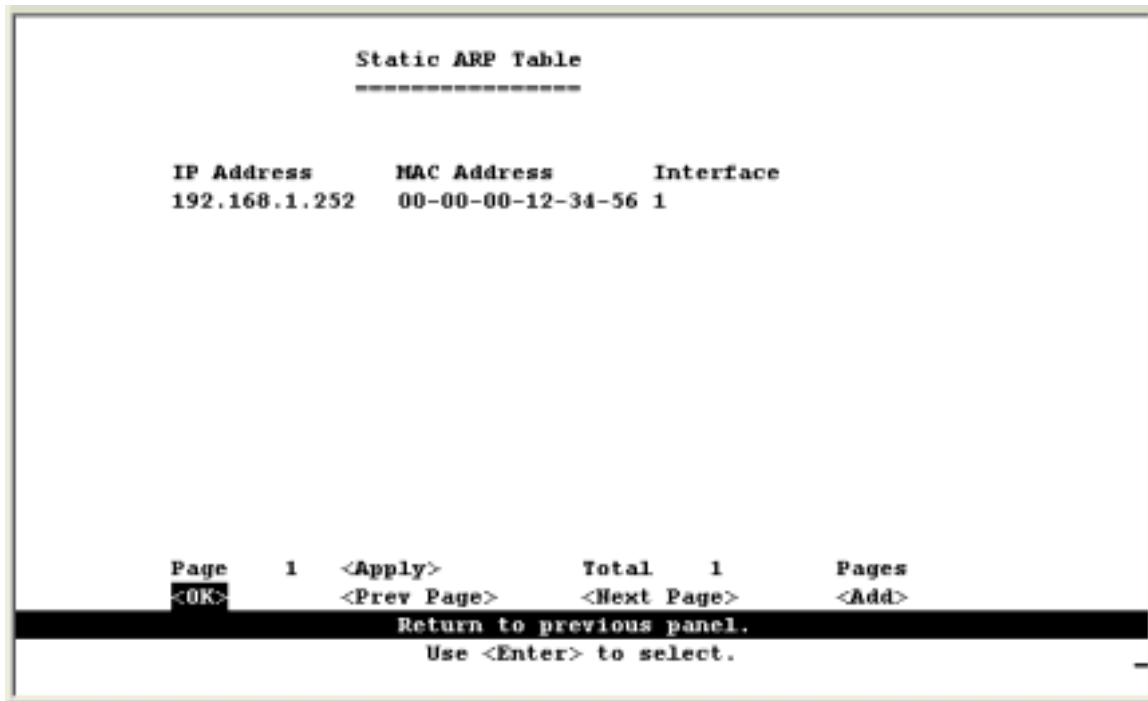

Parameter	Description
IP Address	IP address statically mapped to a physical MAC address.
MAC Address	MAC address statically mapped to the corresponding IP address.
Interface	The index number of the IP interface that will use this static ARP entry. (Port "0" refers to the CPU.)

4.5.6.4 Static Route Configuration

This switch can be configured to dynamically learn the routes to other IP networks, subnets or hosts using unicast or multicast routing protocols. If the route to a specific destination cannot be learned via these protocols or you wish to restrict the path used for transmitting traffic to a destination, then it can be statically configured using the Static Route Table.

Before defining a static route, remember that you must first configure at least one IP interface on this switch. Static routes take precedence over dynamically learned routes, and remain in the table until you remove them or the corresponding IP interface from this switch.

```

                Static Route Table
                -----
Destination Network  Destination Mask  VLAN  Next Hop  Type
10.1.3.0            255.255.255.0    1    203.70.249.250  Indirect

Page 1 <Apply>      Total 1 Pages
<OK> <Prev Page> <Next Page> <Add>
Add routing entry.
Use <TAB> or arrow keys to move. <Enter> to select.

```

Parameter	Description
Destination Network	A destination network, subnet or host.
Destination Mask	The subnet mask that specifies the bits to match. A routing entry will be used for a packet if the bits in the address set by the destination mask match the Destination Network.
VLAN	The VLAN within which the gateway or destination address resides.
Next Hop	The IP address of the router at the next hop. Note that the network portion of the next hop must match that used for one of the subnet IP interfaces configured on this switch. (See "4.5.6.1 Subnet Configuration")
Type	The IP route type for the destination network. This switch supports the following types: Direct - A directly connected subnetwork. Indirect - A remote IP subnetwork or host address.

NOTE: Use the <Next Page> and <Prev Page> buttons to scroll through the static route table. To display a specific page, set the page number in the Page field and then press <Apply>. To modify a static route, highlight the entry in the table and press Enter. To add a static route, press <Add>.

The following screen is displayed for modifying or adding a static route. You must provide route information as described in the preceding table, plus the routing metric used to indicate the number of hops to the destination network.



```

Add Routing Entry
-----

Destination Address: 10.1.16.0
Destination Mask   : 255.255.255.0
Next Hop           : 192.168.1.250
Routing Metric     : 3

<OK>                <Cancel>
Save current screen setting and return to previous panel.
Use <TAB> or arrow keys to move. <Enter> to select.

```

4.5.6.5 Configuring the Default Route

Defines the router to which this switch will forward all traffic for unknown networks. The default route can be learned from RIP protocol (See "4.5.6.1.4 Configuring RIP") or manually configured. If the switch does not contain a default route, any packet that does not match an entry in the routing table will be dropped. To manually configure a default route, enter the next hop in the following table.

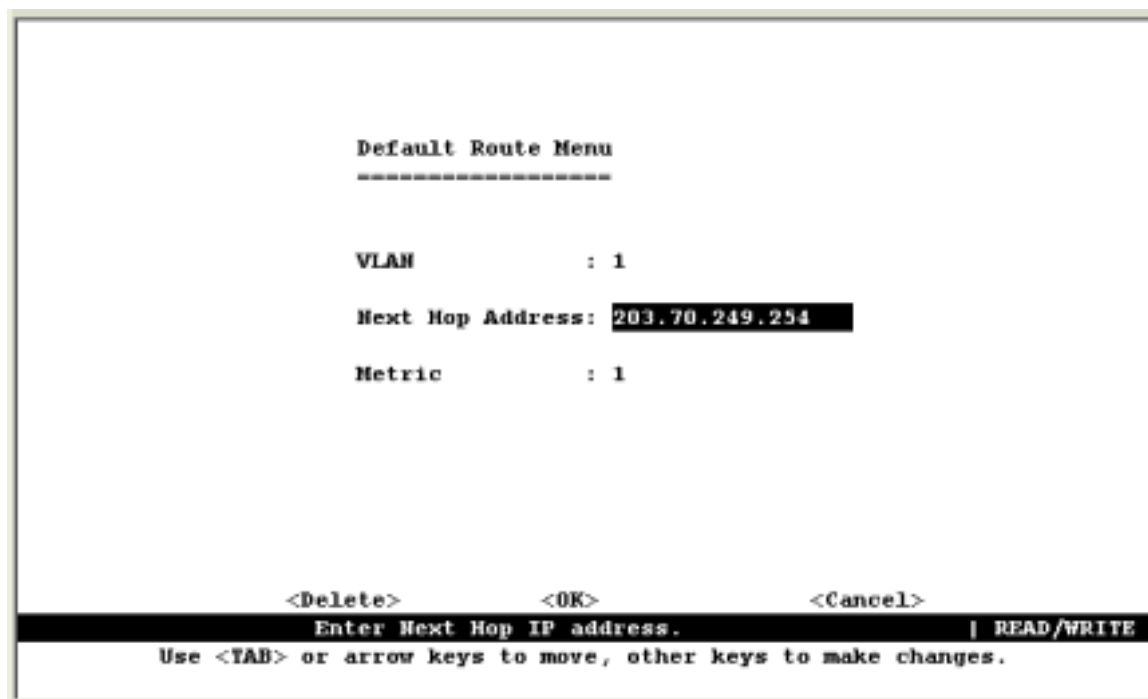

Parameter	Description
VLAN	The VLAN which has the IP interface to the default router.
Next Hop Address	The IP address of the default router.
Metric	The number of hops required to reach the default router.

4.5.7 Security Menu

The Security menu contains options to filter specified MAC or IP addresses. These menu options are described in the following sections.

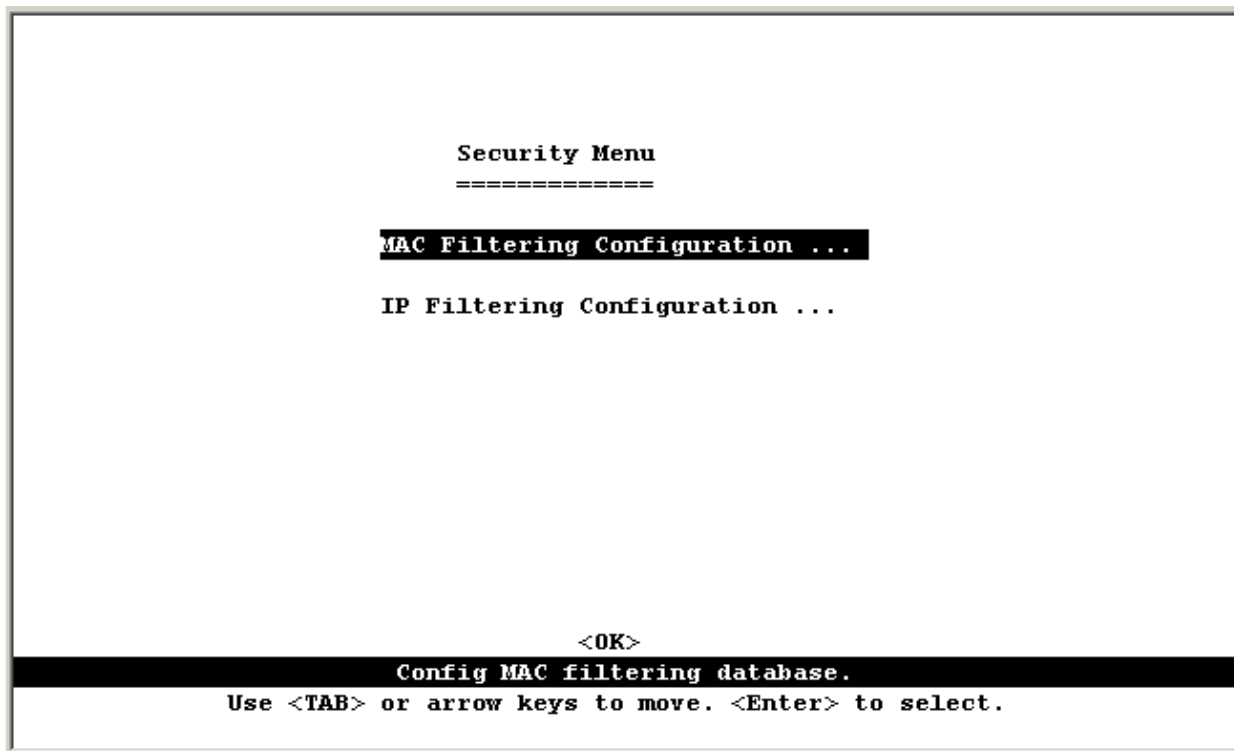

Menu	Description
MAC Filtering Configuration	Specifies the source or destination MAC address for any traffic to be filtered from the switch for security reasons.
IP Filtering Configuration *	Specifies the source or destination IP address for any traffic to be filtered from the switch for security reasons.

* This menu item is only displayed for multilayer mode.

4.5.7.1 Configuring MAC Address Filters

Any node that presents a security risk or is functioning improperly can be filtered from this switch. You can drop all the traffic from a host device based on a specified MAC address. Traffic with either a source or destination address listed in the Security Filtering Configuration table will be filtered.

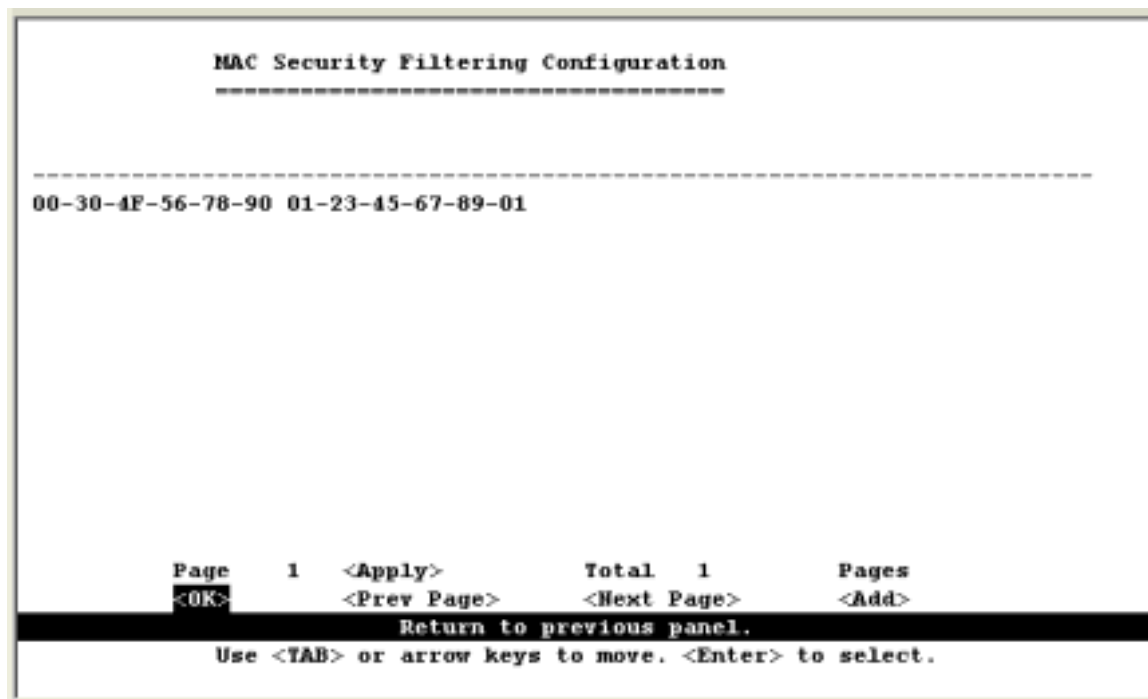

NOTE: To add a MAC address to the security filtering, use <Add>. To delete an address, highlight it with the cursor and press Enter. To scroll through the address table, use the <Next Page> and <Prev Page> buttons. To display a specific page, set the page number in the Page field and then press <Apply>.

4.5.7.2 IP Filtering Configuration

If any node presents a security risk, you can filter all traffic for this node by entering its address into the IP Security Filtering Configuration. Any packet passing through the switch that has a source or destination IP address matching an entry in this table will be filtered.

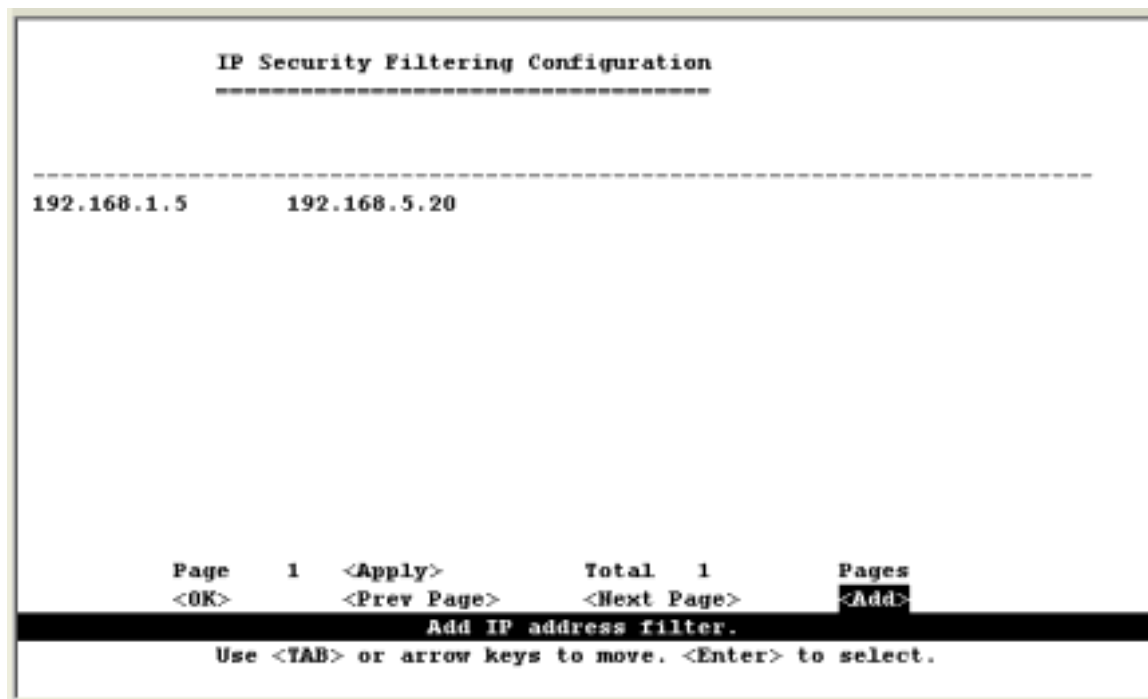

NOTE: To add a IP address to the security filter, use <Add>. To delete an address, highlight it with the cursor and select Enter. Use the <Next Page> and <Prev Page> buttons to scroll through the table. To display a specific page, set the page number in the Page field and then press <Apply>. To add an entry, press <Add>.

4.5.8 Jumbo Packet Configuration

This menu is only available for WGS3-404. In general, Ethernet only allow maximum 1518 bytes packet size. This option allow the switch to transmit up to 9216 bytes packet size to increase data transmission efficiency.

```

Jumbo Packet Configuration
=====

Load Default Size : YES

Jumbo Packet Length : 1536

<Apply>           <Return>           <Cancel>
Load default jumbo size (1536) | READ/SELECT
Use <TAB> or arrow keys to move, <Space> to scroll options.

```

Parameter	Default	Description
Load Default Size	YES	Select YES to use default packet size: 1536. To enable Jumbo Packet function, Toggle it to NO.
Jumbo Packet Size	1536	Specify the maximum packet size allowed on this switch. Range: 1536 to 9216

4.6 Monitoring the Switch

The Network Monitor Menu provides access to port statistics, address tables, STA information, VLANs registration and forwarding information, multicast groups. Each of the screens provided by these menus is described in the following sections.

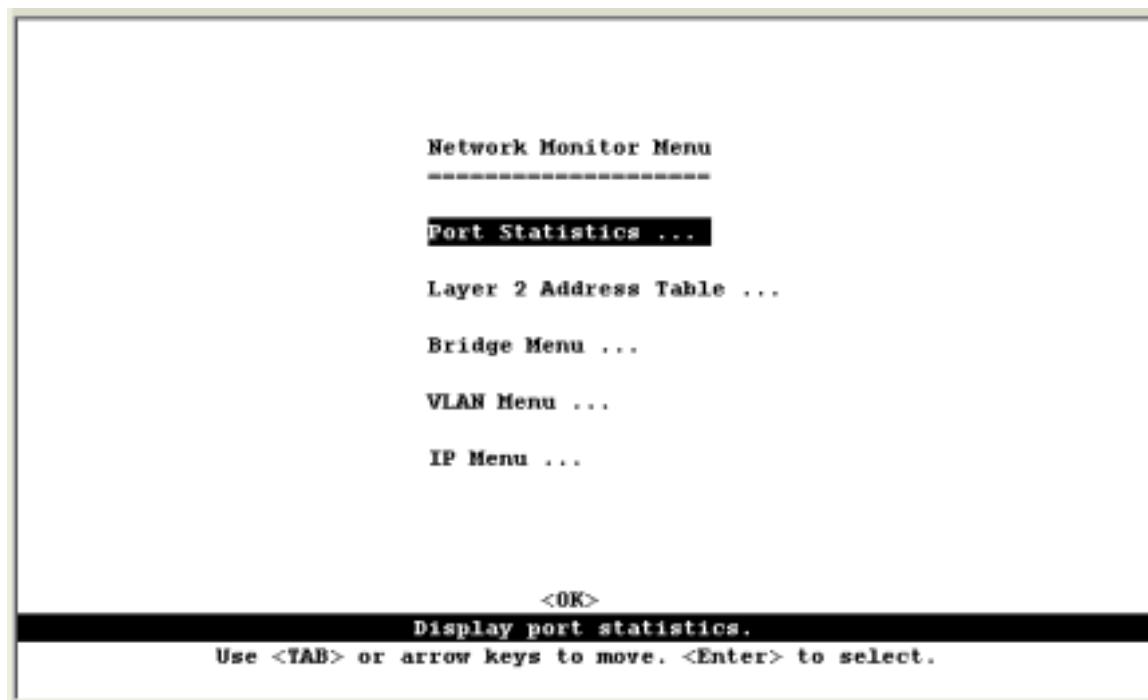

Menu	Description
Port Statistics	Displays statistics on port traffic, including information from the Interfaces Group, Ethernet-like MIB, and RMON MIB.
Layer 2 Address Table	Contains the unicast address table.
Bridge Menu	Displays Spanning Tree settings for the overall switch and for specific ports.
VLAN Menu	Displays ports dynamically learned through GMRP or GVRP, and ports that are currently forwarding VLAN traffic.
IP Multicast Registration Table ^{*1}	Displays all the multicast groups active on this switch, including the multicast IP address and the corresponding VLANs.
IP Menu ^{*2}	Displays all the IP subnets used on this switch, as well as the corresponding VLANs and ports. Also contains the ARP table, routing table and multicast menu.

*1: This menu is only displayed if WGS3-2620 is set to Layer 2 mode.

*2: This menu is only displayed on WGS3-404 or WGS3-2620 when it is set to multilayer mode.

4.6.1 Displaying Port Statistics

Port Statistics display standard statistics on network traffic from the Interfaces Group and Ethernet-like MIBs, as well as a detailed breakdown of traffic based on the RMOM MIB.

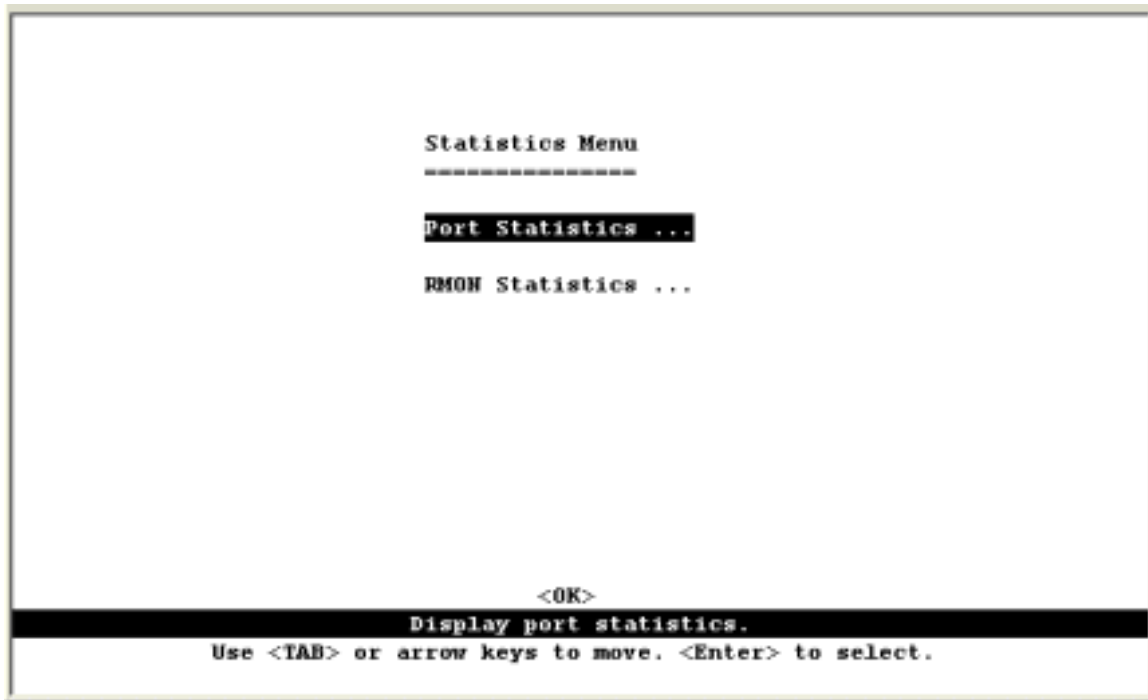

Menu	Description
Port Statistics	Displays statistics on network traffic passing through the selected port.
RMON Statistics	Displays detailed statistical information for the selected port such as packet type and frame size counters.

4.6.1.1 Displaying Ethernet Port Statistics

Port Statistics display key statistics from the Interfaces Group and Ethernet MIBs for each port. Error statistics on the traffic passing through each port are displayed. This information can be used to identify potential problems with the switch (such as a faulty port or unusually heavy loading). The values displayed have been accumulated since the last system reboot.

Select the required port. The statistics displayed are indicated in the following figure and table.

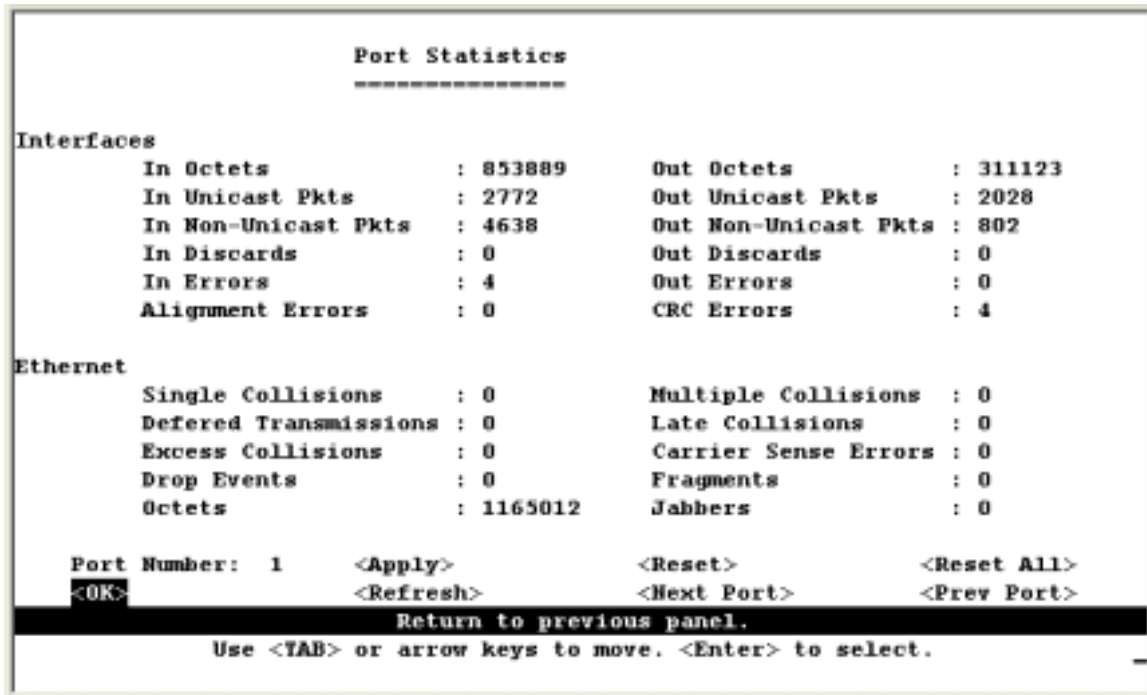

Parameter	Description
Interfaces Group	
In Octets	The total number of octets received on the interface, including framing characters.
In Unicast Pkts	The number of subnetwork-unicast packets delivered to a higher-layer protocol.
In Non-Unicast Pkts	The number of non-unicast (that is, subnetwork- broadcast or subnetwork-multicast) packets delivered to a higher-layer protocol.
In Discards	The number of inbound packets which were chosen to be discarded even though no errors had been detected to prevent their being deliverable to a higher-layer protocol. One possible reason for discarding such a packet could be to free up buffer space.
In Errors	The number of inbound packets that contained errors preventing them from being deliverable to a higher-layer protocol.
Alignment Errors	The number of alignment errors (mis-synchronized data packets).
Out Octets	The total number of octets transmitted out of the interface, including framing characters.
Out Unicast Pkts	The total number of packets that higher-level protocols requested be transmitted to a

	subnetwork-unicast address, including those that were discarded or not sent.
Out Non-Unicast Pkts	The total number of packets that higher-level protocols requested be transmitted to a non- unicast (that is, a subnetwork-broadcast or subnetwork-multicast) address, including those that were discarded or not sent.
Out Discards	The number of outbound packets which were chosen to be discarded even though no errors had been detected to prevent their being transmitted. One possible reason for discarding such a packet could be to free up buffer space.
Out Errors	The number of outbound packets that could not be transmitted because of errors.
CRC Errors	Number of Ethernet Cyclic Redundancy Check errors detected by this device.

Ethernet-Like

Single Collisions	The number of successfully transmitted frames for which transmission is inhibited by exactly one collision.
Deferred Transmissions	A count of frames for which the first transmission attempt on a particular interface is delayed because the medium was busy.
Excessive Collisions	The number of frames for which transmission failed due to excessive collisions.
Drop Events	The total number of events in which packets were dropped due to lack of resources
Octets	Number of octets passing through this port.
Multiple Collisions	A count of successfully transmitted frames for which transmission is inhibited by more than one collision.
Late Collisions	The number of times that a collision is detected later than 512 bit-times into the transmission of a packet.
Carrier Sense Errors	The number of times that the carrier sense condition was lost or never asserted when attempting to transmit a frame.
Fragments	The total number of frames received that were less than 64 octets in length (excluding framing bits, but including FCS octets) and had either an FCS or alignment error.
Jabbers	The total number of frames received that were longer than 1518 octets (excluding framing bits, but including FCS octets), and had either an FCS or alignment error.

NOTES: Statistics are refreshed every 10 seconds by default (See “4.4.2 Configuring the Serial Port”).

4.6.1.2 Displaying RMON Statistics

Use the RMON Statistics screen to display key statistics for each port from RMON group 1. (RMON groups 2, 3 and 9 can only be accessed using SNMP management software.) The following screen displays the overall statistics on traffic passing through each port. RMON statistics provide access to a broad range of statistics, including a total count of different frame types and sizes passing through each port. Values displayed have been accumulated since the last system reboot.

```

                                RMON Statistics
                                -----

Drop Events           : 0           Jabbers              : 0
Bytes                 : 2042730      Collisions            : 0
Frames               : 18036         64 Byte Frames       : 8691
Broadcast Frames     : 9853         65-127 Byte Frames   : 6829
Multicast Frames     : 1798         128-255 Byte Frames  : 1384
CRC/Alignments Errors : 4         256-511 Byte Frames  : 727
Undersize Frames     : 0           512-1023 Byte Frames : 220
Oversize Frames      : 0           1024-1518 Byte Frames : 185
Fragments            : 0           1519-1536 Byte Frames : 0

Port Number: 1      <Apply>          <Reset>              <Reset All>
<OK>              <Refresh>         <Next Port>          <Prev Port>
-----
Return to previous panel.
Use <TAB> or arrow keys to move. <Enter> to select.
```

Parameter	Description
Drop Events	The total number of events in which packets were dropped due to lack of resources.
Bytes	Total number of bytes of data received on the network. This statistic can be used as a reasonable indication of Ethernet utilization.
Frames	The total number of frames (bad, broadcast and multicast) received.
Broadcast Frames	The total number of good frames received that were directed to the broadcast address. Note that this does not include multicast packets.
Multicast Frames	The total number of good frames received that were directed to this multicast address.
CRC/Alignment Errors	The number of CRC/alignment errors (FCS or alignment errors).
Undersize Frames	The total number of frames received that were less than 64 octets long (excluding framing bits, but including FCS octets) and were otherwise well formed. Oversize Frames The total number of frames received that were longer than 1518 octets (excluding framing bits, but including FCS octets) and were otherwise well formed.
Fragments	The total number of frames received that were less than 64 octets in length (excluding framing bits, but including FCS octets) and had either an FCS or alignment error.
Jabbers	The total number of frames received that were longer than 1518 octets (excluding framing bits, but including FCS octets), and had either an FCS or alignment error.
Collisions	The best estimate of the total number of collisions on this Ethernet segment.
64 Byte Frames	The total number of frames (including bad packets) received and transmitted that were 64 octets in length(excluding framing bits but including FCS octets).
65-127 Byte Frames	The total number of frames (including bad packets) received and transmitted where the number of octets fall within the specified range (excluding framing bits but including FCS octets).
128-255 Byte Frames	
256-511 Byte Frames	
512-1023 Byte Frames	
1024-1518 Byte Frames	
1519-1536 Byte Frames	

NOTE: Statistics are refreshed every 10 seconds by default (See “4.4.2 Configuring the Serial Port”).

4.6.2 Layer 2 Address Tables

This menu includes the unicast address table.



Menu	Description
Unicast Address Table	Provides a full listing for unicast addresses

4.6.2.1 Displaying the Unicast Address Table

The Unicast Address Table contains the MAC addresses associated with each port (that is, the source port associated with the address). The information displayed in the Address Table is indicated in the following figure and table.

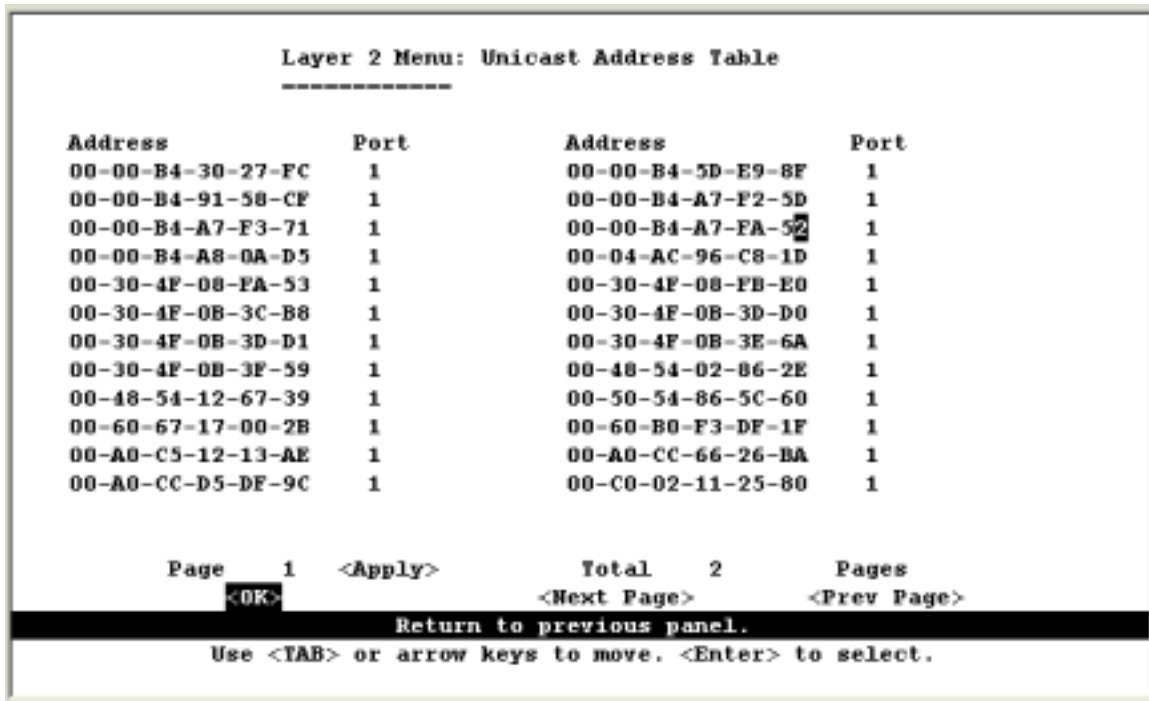

Parameter	Description
Address	The MAC address of a node seen on this switch.
Port	The port whose address table includes this MAC address.

NOTE: Use the <Next Page> and <Prev Page> buttons to scroll through the address table. To display a specific page, set the page number in the Page field and then press <Apply>.

4.6.3 Displaying Bridge Information

The Bridge menu is used to display settings for the Spanning Tree Algorithm. For a more detailed description of how to use this algorithm, refer to “6.1.3 Spanning Tree Algorithm”.

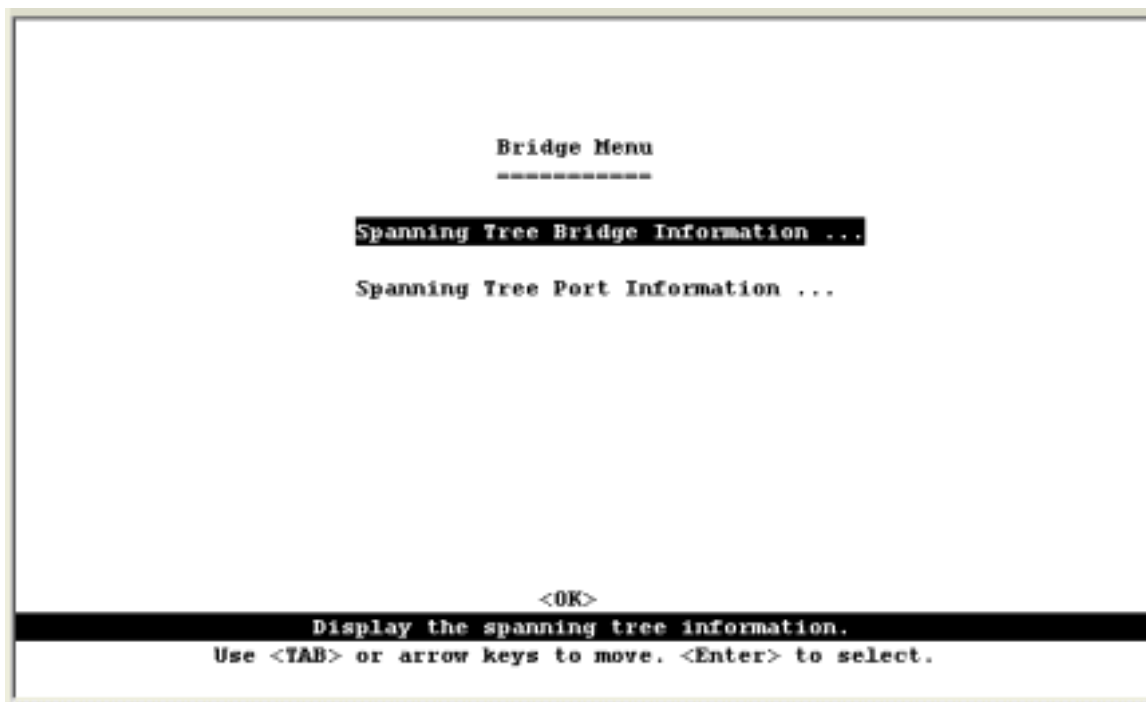

Menu	Description
Spanning Tree Bridge Information	Displays a full list of STA values used for the bridge.
Spanning Tree Port Information	Displays a list of STA values used for each port, including status, designated cost, designated bridge, and designated port.

4.6.3.1 Viewing the Current Spanning Tree Bridge Information

The STA Bridge Information screen displays a summary of STA information for the overall bridge. To make any changes to these parameters, use the Bridge STA Configuration menu. The parameters shown in the following figure and table describe the current bridge STA settings.

```
Bridge Menu: Spanning Tree Bridge Information
*****

Priority                : 32768
Hello Time (in seconds) : 2
Max Age (in seconds)    : 20
Forward Delay (in seconds) : 15
Hold Time (in seconds)  : 1
Designated Root        : 32768.0010B5489400
Root Cost               : 0
Root Port               : 0
Configuration Changes   : 1
Topology Up Time        : 104148 (0 day 0 hr 17 min 21 sec)

<OK>
Return to previous panel.
Use <Enter> to select.
```

Parameter	Description
Priority	Device priority is used in selecting the root device, root port, and designated port. The device with the highest priority becomes the STA root device. However, if all devices have the same priority, the device with the lowest MAC address will then become the root device.
Hello Time	The time interval (in seconds) at which the root device transmits a configuration message.
Max Age	The maximum time (in seconds) a device can wait without receiving a configuration message before attempting to reconfigure.
Forward Delay	The maximum time (in seconds) the root device will wait before changing states (i.e., listening to learning to forwarding).
Hold Time	The minimum interval between the transmission of consecutive Configuration BPDUs
Designated Root	The priority and MAC address of the device in the Spanning Tree that this switch has accepted as the root device.
Root Cost	The path cost from the root port on this switch to the root device.
Root Port	The number of the port on this switch that is closest to the root. This switch communicates with the root device through this port. If there is no root port, then this switch has been accepted as the root device of the Spanning Tree network.
Configuration Changes	The number of times the Spanning Tree has been reconfigured.
Topology Up Time	The time since the Spanning Tree was last reconfigured.

Parameter	Description
Type	Shows port type as: 100TX : 10BASE-T/ 100BASE-TX 1000T : 1000BASE-T 1000FX: 1000Base-SX/1000Base-LX
Status	Displays current state of this port within the Spanning Tree: Disabled - No link has been established on this port. Otherwise, the port has been disabled by the user or has failed diagnostics. Blocking - Port receives STA configuration messages, but does not forward packets. Listening - Port will leave blocking state due to a topology change, starts transmitting configuration messages, but does not yet forward packets. Learning - Port has transmitted configuration messages for an interval set by the Forward Delay parameter without receiving contradictory information. Port address table is cleared, and the port begins learning addresses. Forwarding - The port forwards packets, and continues the learning addresses. The rules defining port status are: <ul style="list-style-type: none"> ◆ A port on a network segment with no other STA compliant bridging device is always forwarding. ◆ If two ports of a switch are connected to the same segment and there is no other STA device attached to this segment, the port with the smaller ID forwards packets and the other is blocked. ◆ All ports are blocked when the switch is booted, then some of them change state to listening, to learning, and then to forwarding.
Designated Cost	The cost for a packet to travel from this port to the root in the current Spanning Tree configuration. The slower the media, the higher the cost.
Designated Bridge (ID)	The priority and MAC address of the device through which this port must communicate to reach the root of the Spanning Tree.
DesignatedPort (ID)	The priority and number of the port on the designated bridging device through which this switch must communicate with the root of the Spanning Tree.

4.6.4 Displaying VLAN Information

These menus display information on the ports that have been automatically learned via GVRP; and all those ports that have been configured by dynamic or static means to forward VLAN traffic.



Menu	Description
VLAN Dynamic Registration Information	Shows the ports that have been automatically learned via GVRP.
VLAN Forwarding Information	Shows all those ports that have been configured by either dynamic or static means to forward VLAN traffic.

4.6.4.1 VLAN Dynamic Registration Information

This table shows the ports that have been automatically learned via GVRP.

VLAN Dynamic Registration Information				

VLAN	Port	1	2	
1		12345678901234567890123456		D
2	D	D		D: Dynamic

Page : 1 <Apply> Total: 1 Pages
<OK> <Prev Page> <Next Page>
Return to previous panel.
Use <TAB> or arrow keys to move. <Enter> to select.

NOTES: To scroll through the dynamic registration table, use the <Next Page> and <Prev Page> buttons.
To display a specific page, set the page number in the Page field and then press <Apply>.

4.6.4.2 VLAN Forwarding Information

Shows all those ports that have been configured by either dynamic or static means to forward VLAN traffic.

```

                                VLAN Forwarding Information
                                -----
VLAN      Port          1          2
1         12345678901234567890123456
1         SSSSSS SSSSSSS SSSSSSSSSSSS          S: Static
2         S          S          D: Dynamic

Page : 1 <Apply>                Total: 1 Pages
<OK>   <Prev Page>   <Next Page>
Enter page number than press 'Apply' to see VLAN group. | READ/WRITE
Use <TAB> or arrow keys to move, other keys to make changes.
```

NOTE: To scroll through the dynamic registration table, use the <Next Page> and <Prev Page> buttons. To display a specific page, set the page number in the Page field and then press <Apply>.

4.6.5 IP Multicast Registration Table

This table displays all the multicast groups active on the switch, including the multicast IP address and the corresponding VLANs.

IP Multicast Registration Table			

VLAN	Multicast IP	1 2	Learned by
1	224.1.1.1	12345678901234567890123456 H	IGMP

Page 1 <Apply> Total 0 Pages
 <OK> <Prev Page> <Next Page>
 The page number. | READ/WRITE
 Use <TAB> or arrow keys to move, other keys to make changes.

Parameter	Description
VLAN	A VLAN with host members that have asked to receive the indicated multicast service.
Multicast IP	A source IP address that represents a specific multicast service.
(Multicast Group Port Lists)	The ports that belong to the indicated VLAN group.
Learned by	Shows if this entry was learned dynamically or via IGMP Snooping. An entry is learned dynamically if a multicast packet was seen crossing the port, or via IGMP Snooping if an IGMP registration packet was seen crossing the port.

NOTE: To scroll through the address table, use the <Next Page> and <Prev Page> buttons. To display a specific page, set the page number in the Page field and then press <Apply>.

4.6.6 IP Address Table

This menu contains IP subnet information, the ARP cache, routing table, as well as multicast groups and multicast routing information.

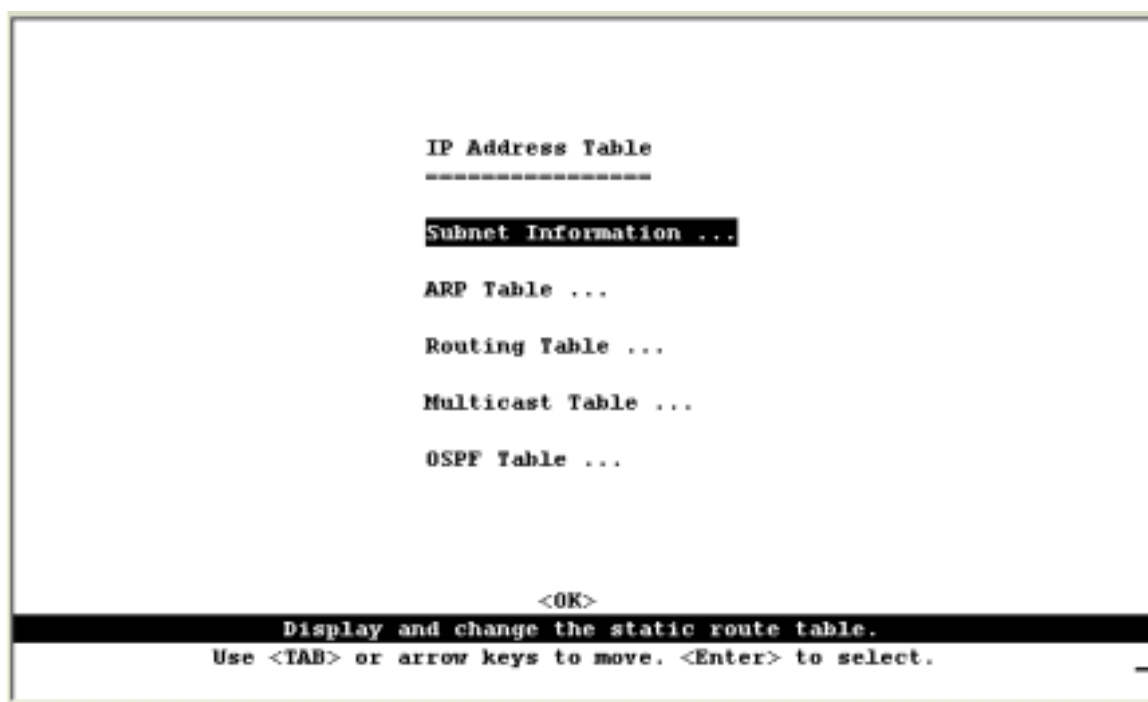

Menu	Description
Subnet Information	Displays a list of all the IP interfaces configured on this switch.
ARP Table	Shows the IP-to-MAC addresses discovered by ARP.
Routing Table	Shows the routes through which all recognized Ethernet networks (and the corresponding VLAN) can be reached.
Multicast Table	Displays all the multicast groups active on this switch, including the multicast IP address and the corresponding VLANs. Also includes the IGMP registration table, the multicast forwarding cache, and DVMRP routing information.
OSPF Table	Displays a link state advertisement summary, the neighbor table, and the virtual neighbor table.

4.6.6.1 Displaying Subnet Information

You can display a list of all the IP interfaces configured on this switch. This table includes the gateway address, corresponding VLAN, and member ports that use this address.

```

Subnet Information
=====
IP Address      Subnet Mask      VLAN 12345678901234567890123456
203.70.249.118 255.255.255.0    1 SSSSSS SSSSSSS SSSSSSSSSSS
192.168.1.254  255.255.255.0    2      S      S

Page 1          <Apply>          Total 1 Pages
<OK>          <Prev Page>      <Next Page>
The page number. | READ/WRITE
Use <TAB> or arrow keys to move, other keys to make changes.
  
```

Parameter	Description
IP Address	The address for an IP interface on this switch.
Subnet Mask	A template that identifies the address bits in the host address used for routing to specific subnets. Each bit that corresponds to a "1" is part of the network / subnet number; and each bit that corresponds to "0" is part of the host number.
VLAN	The VLAN group associated with this IP interface.
(Port Members)	The ports that can be reached through this IP interface.

4.6.6.2 ARP Table

Address Resolution Protocol (ARP) defines a method for finding a host's Ethernet address from its Internet address. This table shows the IP-to-MAC address cache discovered via ARP.

ARP Table			
IP Address	MAC Address	VLAN	Port
192.168.0.7	00-e0-18-0f-19-aa	1	1
192.168.0.254	90-03-28-19-44-01	1	1
192.168.1.156	00-a0-cc-66-26-ba	1	1
192.168.1.253	00-03-2d-00-06-b8	1	1
203.70.249.1	00-00-b4-5d-e9-8f	1	1
203.70.249.2	00-60-67-17-00-2b	1	1
203.70.249.7	00-c0-02-19-82-15	1	1
203.70.249.10	00-06-29-a2-67-41	1	1
203.70.249.11	00-04-ac-96-c8-1d	1	1
203.70.249.21	00-00-b4-c5-43-bc	1	1
203.70.249.22	00-00-b4-92-26-a1	1	1
203.70.249.25	00-30-4f-0b-3c-b9	1	1

Page 1 <OK> <First Page> <Next Page>

Return to previous panel.

Use <TAB> or arrow keys to move. <Enter> to select.

Parameter	Description
IP Address	IP addresses for which ARP has resolved the physical address through a broadcast message.
MAC Address	MAC address that maps to the corresponding IP address.
VLAN	The VLAN group to which this host has been assigned.
Port	The port to which this host device is attached.

4.6.6.3 Routing Table

The Routing Table lists the routes through which all recognized Ethernet networks (and corresponding VLAN) can be reached. This table includes all routes learned through routing protocols or manual configuration.

Routing Table					
Destination Network	Destination Mask	VLAN	Next Hop	Type	Protocol
0.0.0.0	0.0.0.0	1	203.70.249.254	Indirect	Mgmt
203.70.249.0	255.255.255.0	1	203.70.249.118	Direct	Local

Page 1 <Apply> Total 1 Pages
<OK> <Prev Page> <Next Page> <Flush RIP>

Return to previous panel.

Use <TAB> or arrow keys to move. <Enter> to select.

Parameter	Description
Destination Network	A destination network, subnet or host.
Destination Mask	The subnet mask that specifies the bits to match. A routing entry will be used for a packet if the bits in the address set by the destination mask match the Destination Network.
VLAN	The VLAN within which the gateway or destination address resides.
Next Hop	The IP address of the router at the next hop.
Type	The IP route type for the destination network. This switch supports the following types: Direct - A directly connected subnetwork. Indirect - A remote IP subnetwork or host address. Myself - A switch IP address on a specific IP subnetwork. Bcast - A subnetwork broadcast address. Mcast - An IP multicast address. Invalid - An illegal IP address to be filtered.
Protocol	The route was learned in one of the following ways: Local - Manually configured Mgmt - Set via SNMP ICMP - Obtained via ICMP redirect. RIP - Learned via RIP protocol. OSPF – Learned via OSPF protocol. Other - Learned by some other method.

NOTE: Use the <Next Page> and <Prev Page> buttons to scroll through the routing table. To display a specific page, set the page number in the Page field and then press <Apply>. Select <Flush RIP> to clear any routing entries learned through RIP.

4.6.6.3.1 Displaying Detailed Routing Information

To display detailed routing information, select any entry in the Routing Table with your cursor and press Enter. The following screen will display. All the items displayed on this page are the same as that shown in the Routing Table, except for Routing Metric, which represents a relative measure of the path cost from this switch to the destination network. (Note that this metric depends on the specific routing protocol.)

```

Detailed Routing Entry
-----

Destination Address: 203.70.249.0
Destination Mask   : 255.255.255.0
VLAN              : 1

Next Hop          : 203.70.249.118
Type              : Direct
Protocol          : Local

Routing Metric    : 1

<OK>
Return to previous panel.
Use <Enter> to select.

```

4.6.6.4 Multicast Table

You can use this menu to display all the multicast groups currently active on this switch, the IGMP registration table, the multicast forwarding cache, and DVMRP routing information.

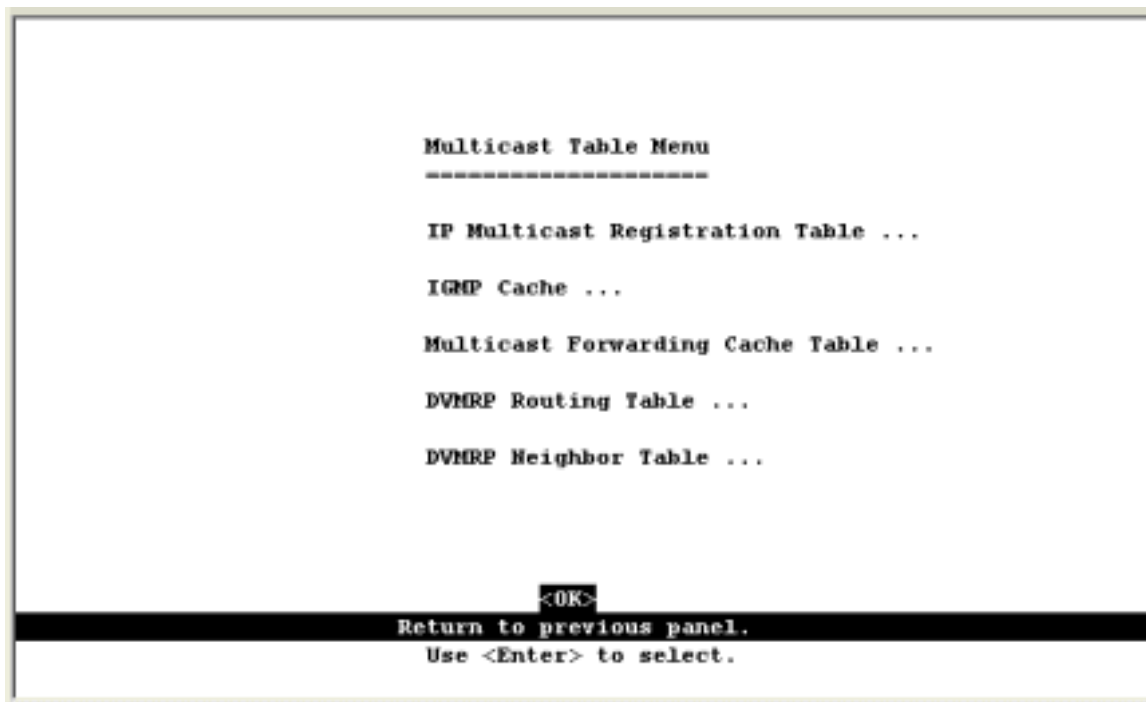

Parameter	Description
IP Multicast Registration Table	Displays all active multicast groups, including the multicast IP address and the corresponding VLANs. (See 4.6.5 IP Multicast Registration Table.)
IGMP Registration Table	Displays all active multicast groups, including the IP interface each entry appears on, the entry age, and the time left before the entry is aged out.
Multicast Forwarding Cache Table	Displays all active multicast groups, including the multicast source address, the upstream neighbor, the multicast routing protocol, and the entry age.
DVMRP Routing Table	Displays the source address for each known multicast service, the upstream neighbor, the IP interface each entry appears on, the routing metric, and the entry age.
DVMRP Neighbor Table	Displays all the neighbor routers accessible through each IP interface, including the entry age, the time left before the entry is aged out, the protocol version, and the number of routing updates received from each neighboring router.

4.6.6.4.1 Displaying IGMP Registration Table

The switch provides a local registry of active multicast groups for each IP interface, including the age and expiration time for each entry.

IGMP Cache					
Group Address	Intf	Reporter	Up Time	Expire	V1 Timer
234.7.6.99	1	10.1.10.19	4200	37500	0

Page 1 <Apply> Total 0 Pages
<OK> <Prev Page> <Next Page>

The page number. | READ/WRITE

Use <TAB> or arrow keys to move, other keys to make changes.

Parameter	Description
Group Address	An IP multicast group address with subscribers directly attached or downstream from this switch.
Intf	The IP interface on this switch that has received traffic directed to the IP multicast group address. (See 4.6.6.1 Displaying Subnet Information.)
Reporter	IP address of the source of the last membership report received for this multicast group on this interface. If no membership report has been received, this object has the value 0.0.0.0.
Up Time	The time elapsed since this entry was created.
Expire	The time remaining before this entry will be aged out. (The default is 260 seconds.)
V1 Timer	<p>The time remaining until the switch assumes that there are no longer any IGMP Version 1 members on the IP subnet attached to this interface. (The default is 400 seconds.)</p> <p>If the switch receives an IGMP Version 1 Membership Report, it sets a timer to note that there are Version 1 hosts present which are members of the group for which it heard the report.</p> <p>If there are Version 1 hosts present for a particular group, the switch will ignore any Leave Group messages that it receives for that group.</p>

NOTE: To scroll through the table, use the <Next Page> and <Prev Page> buttons. To display a specific page, set the page number in the Page field and then select <Apply>.

4.6.6.4.2 Displaying the Multicast Forwarding Cache

The switch maintains a cache of multicast routing entries used to calculate the delivery tree in multicast routing protocols. The Multicast Forwarding Cache includes the subnetwork that contains the multicast source and the nearest upstream neighbor for each known multicast group address.

```

Multicast Forwarding Cache
=====
Group Address  Source Address  Mask  Upstream Nbr  Protocol  Up Time
234.7.6.99    10.1.0.0        16    10.1.15.19    DVMRP     17

Page 1        <Apply>                Total 0 Pages
<OK>         <Prev Page>           <Next Page>
-----
The page number. | READ/WRITE
Use <TAB> or arrow keys to move, other keys to make changes.

```

Parameter	Description
Group Address	An IP multicast group address with subscribers directly attached or downstream from this switch.
Source Address	The IP subnetwork at the root of the multicast delivery tree. This subnetwork contains a known multicast source.
Mask	Subnet mask that is used for the source address. This mask identifies the host address bits used for routing to specific subnets.
Upstream Nbr	The IP address of the network device immediately upstream for this group.
Protocol	The multicast routing protocol associated with this entry.
Up Time	The time elapsed since this entry was created.

NOTE: To scroll through the table, use the <Next Page> and <Prev Page> buttons. To display a specific page, set the page number in the Page field and then select <Apply>.

4.6.6.4.3 Displaying the DVMRP Routing Table

The DVMRP Routing Table contains all the IP multicast routes learned by the DVMRP protocol. The routes displayed in this table are used by this switch to forward new IP multicast traffic. They do not reflect active multicast flows.

```

DVMRP Routing Table
-----
Source Address  Mask  Upstream Nbr  Interface  Metric  Up Time
192.168.1.0    24    192.168.1.254  1           1       4129
192.168.3.0    24    192.168.3.254  2           1       4127
192.168.4.0    24    192.168.4.254  3           1       4127

Page 1      <Apply>          Total 0 Pages
<OK>      <Prev Page>     <Next Page>
-----
The page number. | READ/WRITE
Use <TAB> or arrow keys to move, other keys to make changes.

```

Parameter	Description
Source Address	The IP subnetwork at the root of the multicast delivery tree. This subnetwork contains a known multicast source.
Subnet Mask	Subnet mask that is used for the source address. This mask identifies the host address bits used for routing to specific subnets.
Upstream Nbr	The IP address of the network device immediately upstream for this multicast delivery tree.
Intf	The IP interface on this switch that connects to the upstream neighbor. (See 4.6.6.1 Displaying Subnet Information.)
Metric	The metric for this interface used to calculate distance vectors.
Up Time	The time elapsed since this entry was created.

NOTE: To scroll through the table, use the <Next Page> and <Prev Page> buttons. To display a specific page, set the page number in the Page field and then select <Apply>.

4.6.6.4 Displaying the DVMRP Neighbor Table

The DVMRP Neighbor Table contains the switch's DVMRP neighbors, as discovered by receiving DVMRP protocol messages.

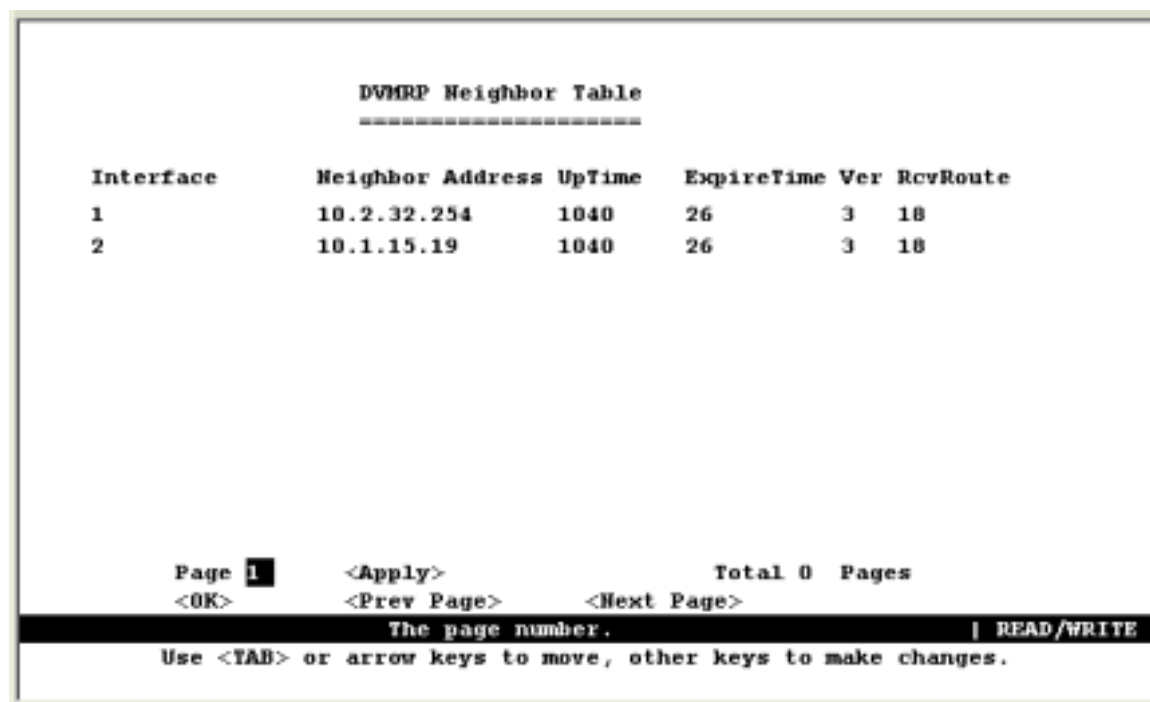

```

DVMRP Neighbor Table
-----
Interface      Neighbor Address  UpTime   ExpireTime  Ver  RcvRoute
1              10.2.32.254      1040     26           3   18
2              10.1.15.19       1040     26           3   18

Page 1         <Apply>                Total 0 Pages
<OK>         <Prev Page>           <Next Page>
-----
The page number. | READ/WRITE
Use <TAB> or arrow keys to move, other keys to make changes.

```

Parameter	Description
Intf	The IP interface on this switch that connects to the upstream neighbor. (See 4.6.6.1 Displaying Subnet Information.)
Neighbor Address	The IP address of the network device immediately upstream for this multicast delivery tree.
UpTime	The time since this device last became a DVMRP neighbor to this switch.
ExpireTime	The time remaining before this entry will be aged out.
Ver	The neighboring router's DVMRP version number.
RcvRoute	The total number of routes received in valid DVMRP packets from this neighbor. This can be used to diagnose problems such as unicast route injection, as well as giving an indication of the level of DVMRP route exchange activity.

NOTE: To scroll through the table, use the <Next Page> and <Prev Page> buttons. To display a specific page, set the page number in the Page field and then select <Apply>.

4.6.6.5 OSPF Table

You can use this menu to display the OSPF router linkages for the autonomous system based on the Link State Table, Neighbor Table, and Virtual Neighbor Table.

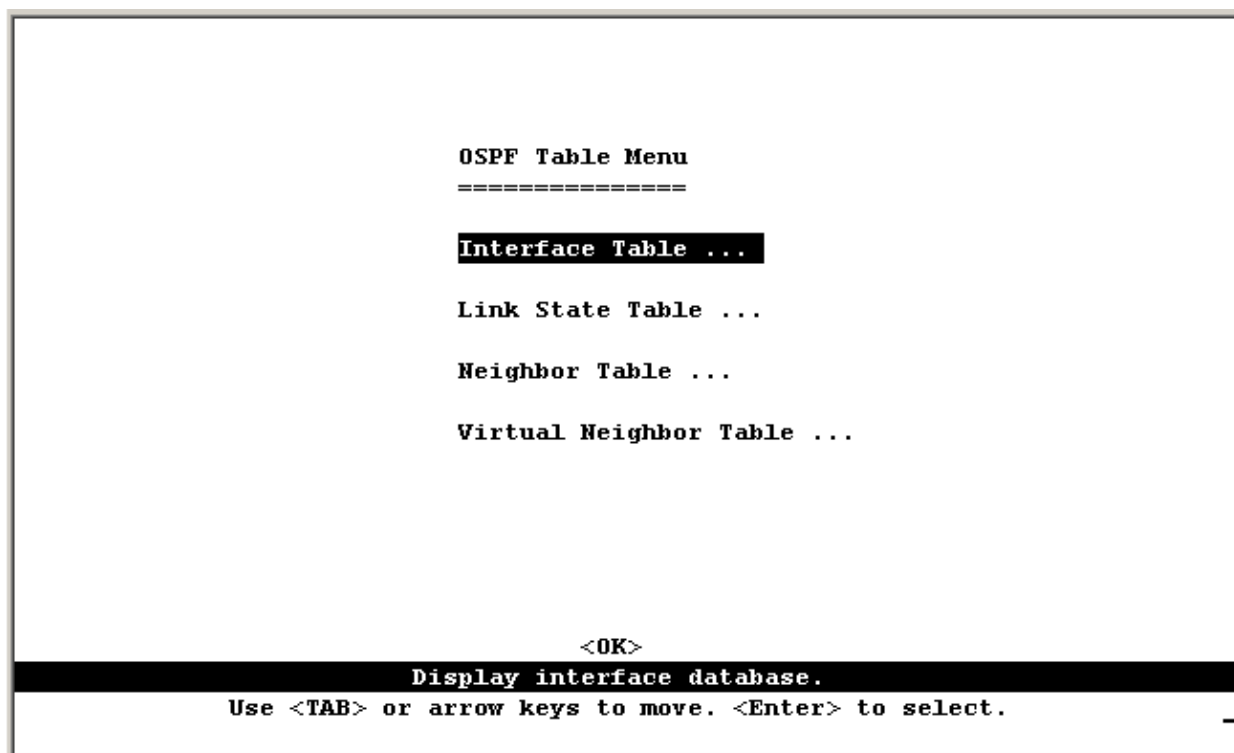

Parameter	Description
Interface Table	Displays interface OSPF status
Link State Table	Displays a summary link state advertisements.
Neighbor Table	Displays current neighbor routers.
Virtual Neighbor Table	Displays current virtual neighbors.

4.6.6.5.1 Display Interface Table

This function allow you to display each IP interface's OSPF status.

OSPF Interface Table					
IP Address	Rtr ID	Designated Rtr	Backup DR	Status	Events
192.168.1.254	0	192.168.1.254	0.0.0.0	DR	1

Page : 1 <Apply> Total : 1 ages
 <OK> <Prev Page> <Next Page>

The page number. | READ/WRITE

Use <TAB> or arrow keys to move, other keys to make changes.

Parameter	Description
IP Address	IP address of the interface
Rtr ID	The OSPF identifier for the neighboring router.
Designated Rtr	The designated router IP address for the broadcast network on the interface
Backup Rtr	The backup designated router IP address for the broadcast network on the interface
Status	The interface status.
Events	The number of events encountered that cause a neighbor state change since boot up.

4.6.6.5.2 Displaying the Link State Table

The link state table displays all advertisements in the link state database. This database contains linkage information for all the areas to which this router is attached. Note that all the routers within an area exchange information to ensure that they maintain an identical link state database. This database can therefore be used to troubleshoot network configuration problems.

OSPF Link State Table					
=====					
Area Identity	Type	Link State Id	Router ID	Sequence No	Age
0.0.0.0	RtrLSA	192.168.1.254	192.168.1.254	0x80000002	562
192.168.1.0	RtrLSA	192.168.1.254	192.168.1.254	0x80000003	516

Page : **1** <Apply> Total : 1 ges
<OK> <Prev Page> <Next Page>

The page number. | READ/WRITE

Use <TAB> or arrow keys to move, other keys to make changes.

Parameter	Description
Area Identity	An OSPF area identifier configured for a group of OSPF routers.
Type	<p>The link state advertisement type:</p> <p>RtrLSA: Router LSA – All area routers advertise the state of links from the router itself to the its local area.</p> <p>NetLSA: Network LSA – The designated router for each area advertises the link state for each transit area; i.e., an area with more than one attached router. This LSA includes information about each router attached to the area, including the designated router itself.</p> <p>SumLSA: Summary LSA – Advertise the cost to a specific subnetwork outside the router's area, or the cost to a specific autonomous system boundary router.</p> <p>ExtLSA: External LSA – Advertises link state information for each known network outside the autonomous system.</p>
Link State ID	The identifier for the router originating this entry, usually in the form of an IP address.
Router ID	The IP address of the originating router.
Sequence No.	The link state sequence number, used to remove previous duplicate LSAs.
Age	The number of seconds since this LSA was originated.

4.6.6.5.3 Displaying the Neighbor Table

Each router exchanges link state information with all neighbors physically attached to the same network segment. This table displays a summary of the link state for all adjacent neighbors. (Note that neighboring routers are discovered by this device via Hello messages.)

```

                OSPF Neighbor Table
                =====
IP Address      ID      Router ID      Option  Priority State  Events
192.168.4.254  0      192.168.4.254  3      1      Full      6

Page : 1      <Apply>      Total : 0 ages
<OK>      <Prev Page>      <Next Page>
-----
                The page number.      | READ/WRITE
Use <TAB> or arrow keys to move, other keys to make changes.

```

Parameter	Description
IP Address	IP address of the neighboring router
ID	The index number of the router interface to which this neighbor is attached. For IP protocol, this value will always be zero.
Router ID	The OSPF identifier for the neighboring router.
Option	The optional OSPF capabilities supported by the neighbor. The neighbor's optional OSPF capabilities are also listed in its Hello packets. This enables received Hellos to be rejected (i.e., neighbor relationships will not even start to form) if there is a mismatch in certain crucial OSPF capabilities. The OSPF optional capabilities currently accepted include external routing capability and TOS capability. You need to map the binary bits to the supported options. For example, "3" indicates both routing capability and TOS capability.
Priority	The neighbor's router priority. This priority is used in electing the designated router for the area in which it exists. This value will be set to zero if this router cannot be elected.

State

The communication state for two adjacent routers:

Down: This is the initial state of a neighbor conversation. It indicates that there has been no recent information received from the neighbor.

Attempt: This state is only valid for neighbors attached to non-broadcast networks. It indicates that no recent information has been received from the neighbor, but that the router is attempting to contact the neighbor by sending Hello packets.

Init: A Hello packet has recently been seen from the neighbor. However, bidirectional communication has not yet been established with the neighbor.

2-Way: Communication between the two routers has been established. This is the most advanced state short of beginning adjacency establishment. Note that both the Designated Router and Backup Designated Router are selected from the set of neighbors in state 2-Way or greater.

ExStart: This is the first step in creating an adjacency between the two neighboring routers. The goal of this step is to decide which router is the master, and to decide upon the initial sequence number. Neighbor conversations in this state or greater are called adjacencies.

Exchange: The router is describing its entire link state database by sending database description packets to the neighbor. (Each database description packet has a sequence number, and is explicitly acknowledged.) All adjacencies in Exchange state or greater are used by the flooding procedure. In fact, these adjacencies are fully capable of transmitting and receiving all types of OSPF routing protocol packets.

Loading: Link State Request packets are sent to the neighbor asking for more recent advertisements that have been discovered (but not yet received) in the Exchange state.

Full: The neighboring routers are fully adjacent. These adjacencies will now appear in router links and network links advertisements.

Events

The number of events encountered that cause a neighbor state change since boot up.

4.6.6.5.4 Displaying the Virtual Neighbor Table

Virtual links can be used to link an area isolated from the backbone, to create a redundant link between any area and the backbone to help prevent partitioning, or to connect two existing backbone areas into a common backbone. Note that the processes of establishing a active link between virtual neighbors is similar to that used for physically adjacent neighbors..

OSPF Virtual Neighbor Table					
Area ID	Router ID	IP Address	Option	State	Events
192.168.9.0	192.168.9.254	192.168.9.254	3	Full	6

Page : 1 <Apply> Total : 0 ages
 <OK> <Prev Page> <Next Page>

The page number. | READ/WRITE

Use <TAB> or arrow keys to move, other keys to make changes.

Parameter	Description
Area ID	The transit area the virtual link must cross to connect the border routers.
Router ID	The OSPF identifier for the router at the other end of the link.
IP Address	IP address of the border router at the other end of the link.
Option	The optional OSPF capabilities supported by the neighbor. The neighbor's optional OSPF capabilities are also listed in its Hello packets. This enables received Hellos to be rejected (i.e., neighbor relationships will not even start to form) if there is a mismatch in certain crucial OSPF capabilities. The OSPF optional capabilities currently accepted include external routing capability and TOS capability. You need to map the binary bits to the supported options. For example, "3" indicates both routing capability and TOS capability.

State

The communication state for two adjacent routers:

Down: This is the initial state of a neighbor conversation. It indicates that there has been no recent information received from the neighbor.

Attempt: This state is only valid for neighbors attached to non-broadcast networks. It indicates that no recent information has been received from the neighbor, but that the router is attempting to contact the neighbor by sending Hello packets.

Init: A Hello packet has recently been seen from the neighbor. However, bidirectional communication has not yet been established with the neighbor.

2-Way: Communication between the two routers has been established. This is the most advanced state short of beginning adjacency establishment. Note that both the Designated Router and Backup Designated Router are selected from the set of neighbors in state 2-Way or greater.

ExStart: This is the first step in creating an adjacency between the two neighboring routers. The goal of this step is to decide which router is the master, and to decide upon the initial sequence number. Neighbor conversations in this state or greater are called adjacencies.

Exchange: The router is describing its entire link state database by sending database description packets to the neighbor. (Each database description packet has a sequence number, and is explicitly acknowledged.) All adjacencies in Exchange state or greater are used by the flooding procedure. In fact, these adjacencies are fully capable of transmitting and receiving all types of OSPF routing protocol packets.

Loading: Link State Request packets are sent to the neighbor asking for more recent advertisements that have been discovered (but not yet received) in the Exchange state.

Full: The neighboring routers are fully adjacent. These adjacencies will now appear in router links and network links advertisements.

Events

The number of events encountered that cause a neighbor state change since boot up.

4.7 Resetting the System

Use the Restart command under the Main Menu to reset the management agent. The reset screen is shown below.

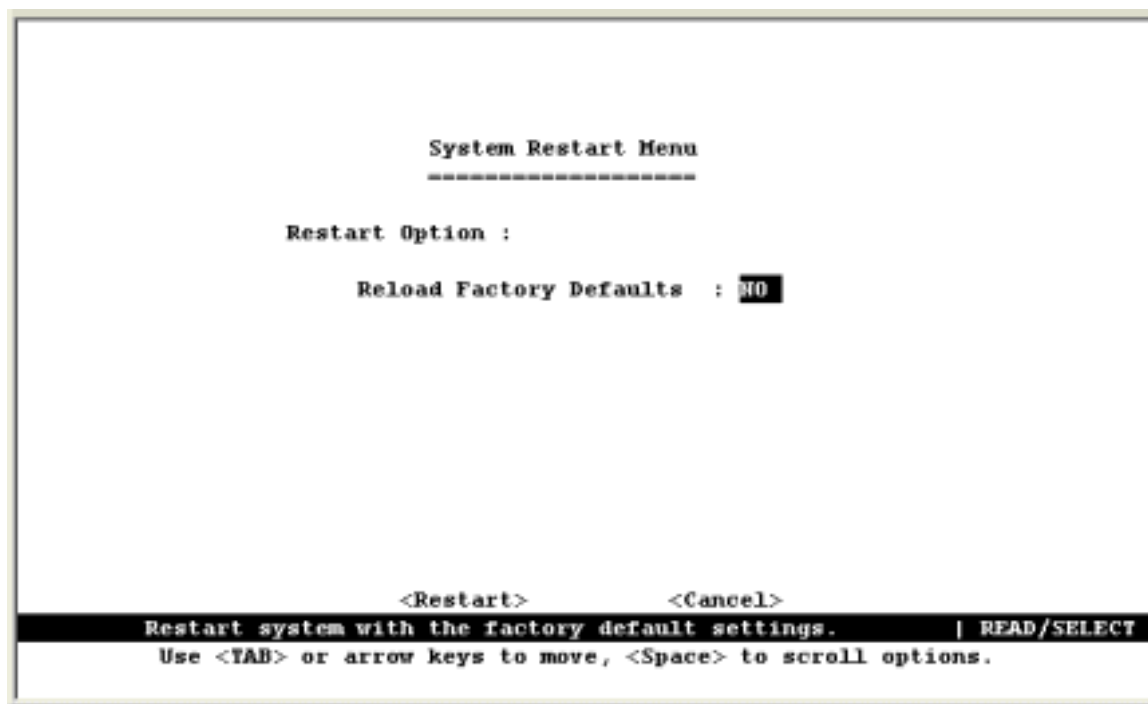

Parameter	Description
Reload Factory Defaults	Reloads the factory defaults
[Restart]	Restarts the switch.

NOTE: When restarting the system, it will always run the Power-On Self-Test. It will also retain all system information, unless you select to reload the factory defaults.

4.8 Logging Off the System

Use the Exit command under the Main Menu to exit the configuration program and terminate communications with the switch for the current session.

```
WGS3-404

Main Menu
=====

System Information Menu...
Management Setup Menu...
Device Control Menu...
Network Monitor Menu...
System Restart Menu...

Exit

Exit this user interface program.
Use <TAB> or arrow keys to move. <Enter> to select.
```

Chapter 5. Web Interface

5.1 Web-Based Configuration and Monitoring

As well as the menu-driven system configuration program, this switch provides an embedded HTTP Web agent. Using a Web browser you can configure the switch and view statistics to monitor network activity. The Web agent can be accessed by any computer on the network using Internet Explorer 4.0 or above Web browser.

NOTE: Current firmware version does not support Netscape Navigator.

Prior to accessing the switch from a Web browser, be sure you have first performed the following tasks:

1. Configure it with a valid IP address, subnet mask, and default gateway (for Layer 2 mode) using an out-of-band serial connection. Provide a default gateway for Layer 2 operation of WGS3-2620 or a default route for WGS3-2620 multilayer operation and WGS3-404 (see 4.5.6.5 Configuring the Default Route).
2. Set a user name and password using an out-of-band serial connection(see 4.4.4 User Login Configuration). Access to the Web agent is controlled by the same user name and password as the on-board configuration program.

NOTE: If the path between your management station and this switch does not pass through any device that uses the Spanning Tree Algorithm, then you can set the switch port attached to your management station to Fast Forwarding (see 4.5.3.2 Configuring STA for Ports) to improve the switch's response time to management commands issued through the Web interface.

After you enter the user name and password, you will have access to the system configuration program illustrated by the following menu hierarchy:

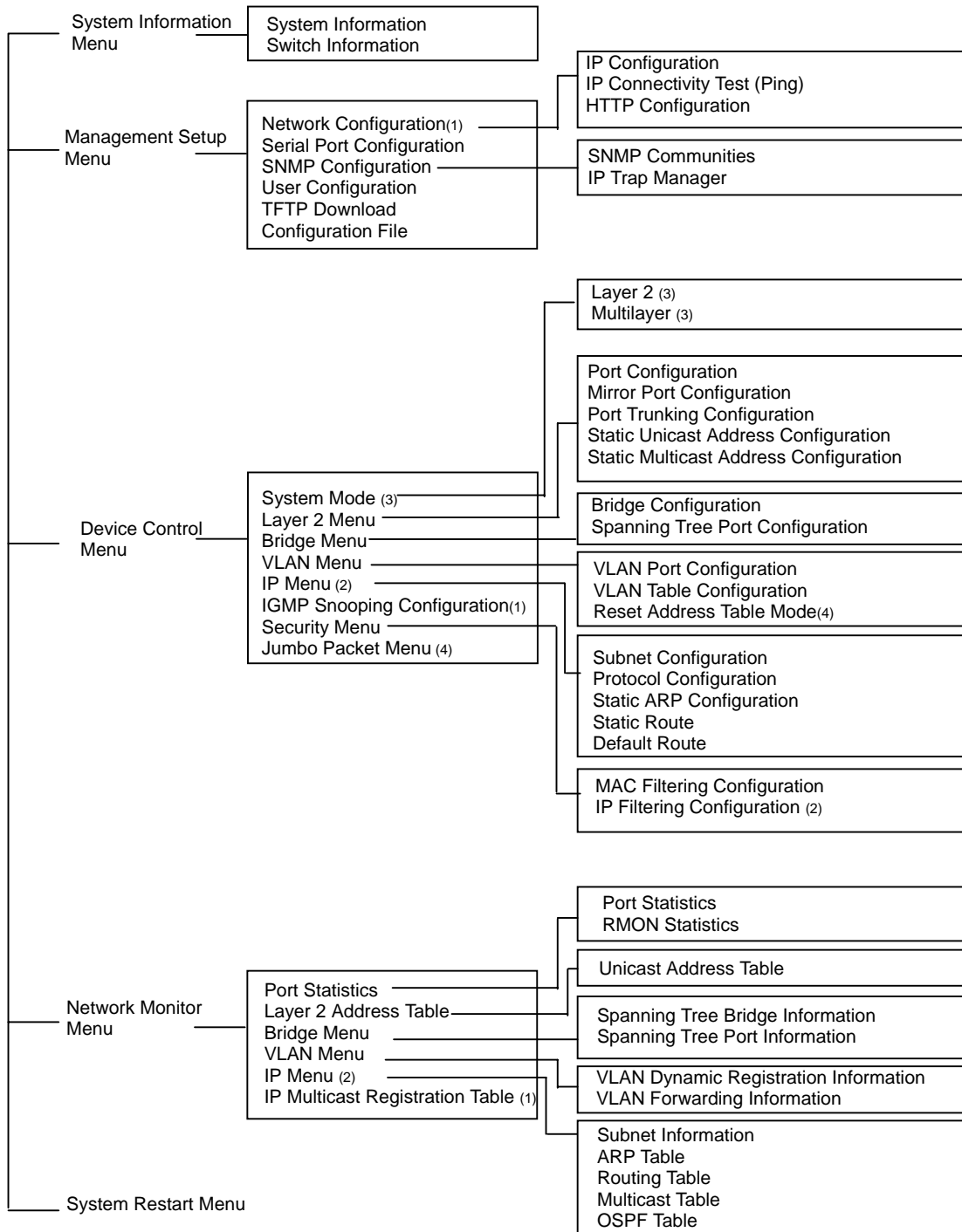

1. Displayed for layer 2 mode of WGS3-2620 only.
2. Displayed for multilayer mode of WGS3-2620 and WGS3-404 only
3. Displayed for WGS3-2620 only
4. Displayed for WGS3-404 only

5.2 Navigating the Web Browser Interface

To access the Web-browser interface you must first enter a user name and password. The administrator has Read/Write access to all configuration parameters and statistics. The default user name for the administrator is "admin" with no password.

5.2.1 Home Page

When your Web browser connects with the switch' s Web agent, the home page is displayed as shown below for WGS3-2620. The home page displays the Main Menu on the left side of the screen and System Information on the right side.

The Main Menu links are used to navigate to other menus and display configuration parameters and statistical data.



The following is the web interface of WGS3-404.

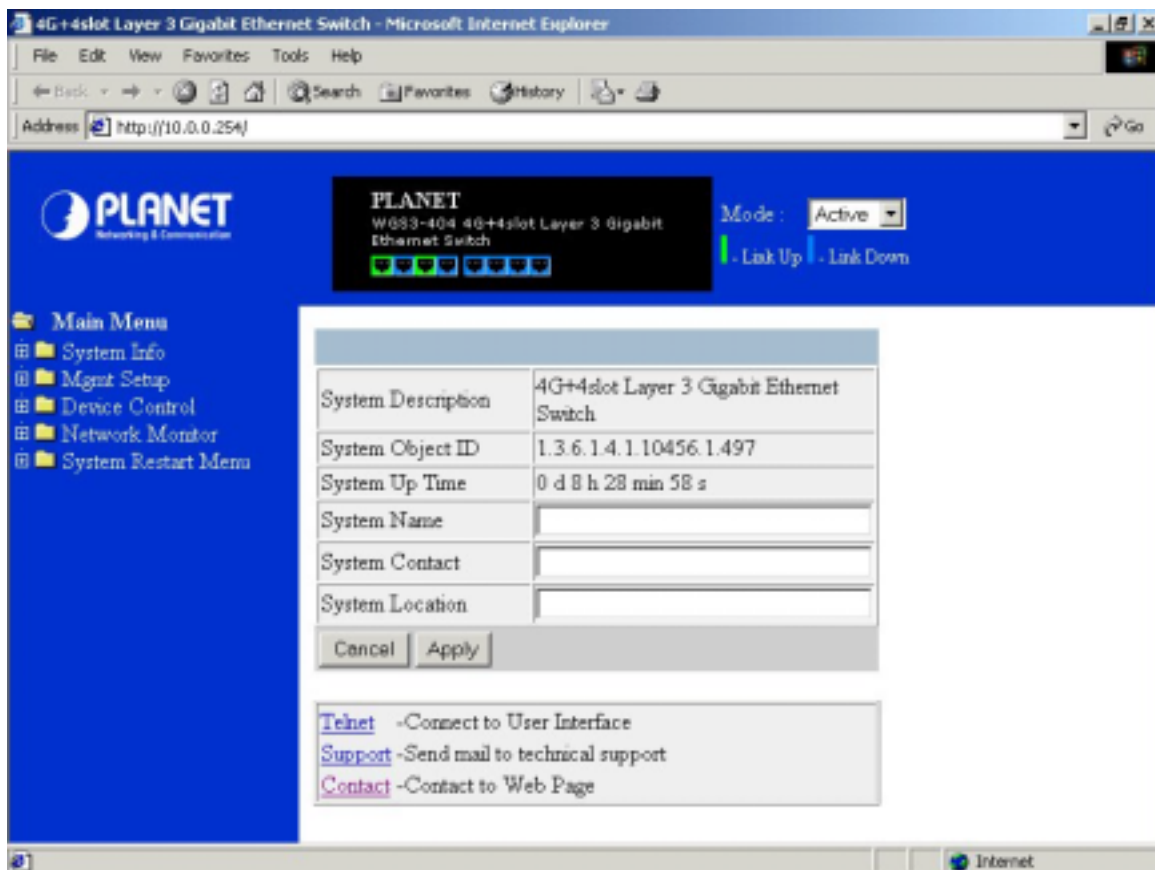

If this is your first time to access the management agent, you should define a new Administrator name and password, record it and put it in a safe place. Select Mgt Setup / User Cfg. from the Main Menu, and then enter a new name and password for the Administrator. Note that user names and passwords can consist of up to 11 alphanumeric characters and are not case sensitive.

NOTE: You are allowed three attempts to enter the correct password; on the third failed attempt the current connection is terminated.

5.2.2 Configuration Options

Configurable parameters have a dialog box or a drop-down list. Once a configuration change has been made on a page, be sure to click on the “Apply” button at the bottom of the page to confirm the new setting. The following table summarizes the Web page configuration buttons.

Web Page Configuration Buttons	
Button	Action
Apply	Sets specified values in the SNMP agent.
Cancel	Cancels specified values prior to pressing the “Apply” button.
Refresh	Immediately updates values from the SNMP agent

NOTE 1. To ensure proper screen refresh, be sure that Internet Explorer 5.0 is configured as follows:
Under the menu “Tools / Internet Options / General / Temporary Internet Files / Settings,” the setting for item “Check for newer versions of stored pages” should be “Every visit to the page.”

NOTE 2. When using Internet Explorer 5.0, you may have to manually refresh the screen after making configuration changes by pressing the browser’s refresh button.

5.3 Panel Display

The Web agent displays an image of the switch's ports, showing port links and activity. Clicking on the image of a port displays statistics and configuration information for the port. Clicking on the image of the serial port (labeled "Mgmt", for WGS2-2620 only) displays the Console Configuration screen. Clicking on any other part of the front panel displays "Displaying Switch Version Information".



5.3.1 Port State Display

Click on any port to display a summary or port status as shown below, as well as Etherlike statistics.

Port 1 state summary	
Name	
Type	100BASE-TX
Admin Status	Enabled
Link Status	Down
Speed Status	10M
Duplex Status	Half
Flow Control Status	Off
VLAN ID	1

Parameter	Description
Type	Shows port type as: 100BASE-TX (10BASE-T / 100BASE-TX) 1000BASE-T, 1000Base-FX
Admin Status	Shows if the port is enabled, or has been disabled due to abnormal behavior or for security reasons. See "Configuring Port Parameters".
Link Status	Indicates if the port has a valid connection to an external device.
Speed Status	Indicates the current port speed.
Duplex Status	Indicates the port's current duplex mode.
Flow Control Status	Shows the flow control type in use. Flow control can eliminate frame loss by "blocking" traffic from end stations connected directly to the switch.
VLAN ID	The VLAN ID assigned to untagged frames received on this port. Use the PVID to assign ports to the same untagged VLAN.

5.3.2 Configuring the Serial Port

If you are having difficulties making an out-of-band console connection to the serial port on the switch, you can display or modify the current settings for the serial port through the Web agent. Click on the serial port icon in the switch image to display or configure these settings, as shown below.

Serial Port Configuration	
Management Mode	CONSOLE MODE
Baud Rate	19200 ▾
Data Bits	8 ▾
Stop Bits	1 ▾
Parity	None ▾
Time-Out	0 minute(s)
Auto-Refresh	10 second(s)
<input type="button" value="Cancel"/> <input type="button" value="Apply"/>	

Parameter	Default	Description
Management Mode	Console Mode	Indicates that the port settings are for direct console connection.
Baud Rate	19200	The rate at which data is sent between devices. Options : 9600, 19200 and 38400 baud.
Data Bits	8 bits	Sets the data bits of the RS-232 port. Options : 7, 8
Stop Bits	1 bit	Sets the stop bits of the RS-232 port. Options : 1, 2
Parity	none	Sets the parity of the RS-232 port. Options : none/odd/even
Time-Out	0 minutes	If no input is received from the attached device after this interval, the current session is automatically closed. Range : 0 - 100 minutes; where 0 indicates disabled
Auto Refresh	10 second	Sets the interval before a console session will auto refresh the console information, such as Spanning Tree Information, Port Configuration, Port Statistics, and RMON Statistics. Range : 0, or 5-255 seconds; where 0 indicates disabled

5.4 Main Menu

Using the on-board Web agent, you can define system parameters, manage and control the switch, and all its ports, or monitor network conditions. The interface screen includes the menu tree on the left side and a list of commands beneath the image of the switch. The following table briefly describes the selections available from this program.

Menu	Description
<i>System Information Menu</i>	
System Information	Provides basic system description, including contact information.
Switch Information	Shows hardware/firmware version numbers, power status, and expansion modules used in the switch.
<i>Management Setup Menu</i>	
Network Configuration ^{*1}	Includes IP Configuration, Ping facility, and HTTP (Web agent) setup.
Serial Port Configuration	Sets communication parameters for the serial port, including baud rate, console time-out, and screen data refresh interval.
SNMP Configuration	Activates authentication failure traps; and configures community access strings, and trap managers.
User Configuration	Sets the user names and passwords for system access.
TFTP Download	Downloads new version of firmware to update your system (in-band).
Configuration File	Save or restores configuration data based on the specified file.
<i>Device Control Menu</i>	
System Mode ^{*3}	Sets the switch to operate as a Layer 2 switch or as a multilayer routing switch.
Layer 2 Menu	Configures port communication mode, mirror ports, port trunking and static unicast/multicast address.
Bridge Menu	Configures GMRP and GVRP for the bridge, and STA for the global bridge or for specific ports.
VLAN Menu	Configures VLAN settings for specific ports, and defines the port membership for VLAN groups.
IGMP Snooping Configuration ^{*1}	Configures IGMP multicast filtering.
IP Menu ^{*2}	Configures the subnets for each VLAN group, global configuration for unicast and multicast protocols, BOOTP/DHCP relay, static ARP table entries, static routes and the default route.
Security	Restrict access through MAC address or IP address ^{*2}

Jumbo Packet Menu ^{*4} Allows the switch to send jumbo packet up to 9k

Network Monitor Menu

Port Statistics Displays statistics on network traffic passing through the selected port, including information from the Interfaces Group, Ethernet-link MIB, and RMON MIB

Layer 2 Address Table Contains the unicast address table.

Bridge Menu Displays Spanning Tree information for the overall bridge and for specified ports.

VLAN Menu Displays dynamic port registration information for VLANs, as well as all VLAN forwarding information for static and dynamic assignment.

IP Multicast Registration Table ^{*1} Displays all the multicast groups active on this switch, including the multicast IP addresses and corresponding VLANs.

IP Menu ^{*2} Displays all the IP subnets used on this switch, as well as the corresponding VLANs and ports. Also contains the ARP table, routing table and multicast table.

Restart System Menu Restarts the system with options to reload factory defaults.

1: Only displays when the WGS3-2620 is set to Layer 2 mode.

2. Only displays when WGS3-2620 is set to multilayer mode and WGS3-404..

3. Only displays when using WGS3-2620.

4. Only displays when using WGS3-404

5.5 System Information Menu

Use the System Information Menu to display a basic description of the switch, including contact information, and hardware/firmware versions.

Menu	Description
System Information	Provides basic system description, including contact information.
Switch Information	Shows hardware/firmware version numbers, power status, and expansion modules used in the stack.

5.5.1 Displaying System Information

Use the System Information screen to display descriptive information about the switch, or for quick system identification as shown in the following figure and table.

System Information

System Description : 24+2G Layer 3 Fast/Gigabit Ethernet Switch

System Object ID : 1.3.6.1.4.1.10456.1.462

System Up Time : 0 d 0 h 6 min 29 s

System Name :

System Contact :

System Location :

Parameter	Description
System Description	System hardware description.
System Name*	Name assigned to the switch system
Object ID	MIB II object identifier for switch' s network management subsystem.
Location*	Specifies the area or location where the system resides.
Contact*	Contact person for the system.
System Up Time	Length of time the current management agent has been running.

* Maximum string length is 99, but the screen only displays 45 characters. You can use the arrow keys to browse the whole string.

5.5.2 Displaying Switch Version Information

Use the Switch Information screen to display hardware/firmware version numbers for the switch system.

5.5.2.1 WGS3-2620

Switch Information
Hardware Version : R01
Firmware Version : V1.01
Serial Number : 00-30-4F-18-E6-40
Number of Ports : 26
Power Status : Active
G1 : 1000MBase-T
G2 : 1000MBase-T

Parameter	Description
Hardware Version	Hardware version of the main board.
Firmware Version	System firmware version in ROM.
Serial Number	Serial number of the main board.
Number of Ports	Number of ports on this switch
Power Status	Power status for the switch.
Fan Power Status	Shows if power to the fan is active or inactive.
G1, G2	Show Connected type of G1 and G2

5.5.2.2 WGS3-404

Main Board:	
Hardware Version	R0C
Firmware Version	V0.61c
Serial Number	00-10-B5-48-95-60
Port Number	8
Packet Memory Size	6M

Parameter	Description
Hardware Version	Hardware version of the main board.
Firmware Version	System firmware version in ROM.
Serial Number	The serial number (MAC address) of the main board.
Port Number	Number of ports on this switch.
Packet Memory Size	Shows memory size for packet buffer. It is always 6M bytes.

5.6 Management Setup Menu

After initially logging onto the system, you can use this menu to configure access rights. You should set user names and passwords (User Configuration). Remember to record them in a safe place. You should also set the community string which controls access to the on-board SNMP agent via in-band management software (SNMP Configuration). The items provided by the Management Setup Menu are described in the following sections.

Menu	Description
Network Configuration	Includes IP setup * and HTTP setup for the on-board Web agent.
Serial Port Configuration	Sets communication parameters for the serial port, including baud rate, console time-out, and screen data refresh interval. (See "Configuring the Serial Port")
SNMP Configuration	Activates authentication failure traps; and configures communities and trap managers.
User Configuration	Sets the user names and passwords for system access.
TFTP Download	Downloads new version of firmware to update your system (in-band).
Configuration File	Saves or restores configuration data based on the specified file.

* Only displays on WGS3-2620 when it is set to Layer 2 mode.

5.6.1 Changing the Network Configuration (Layer 2 Mode of WGS3-2620)

Use the Network Configuration menu to set the bootup option, configure the switch' s Internet Protocol (IP) parameters. The screen shown below is described in the following table.

Parameter	Description
Interface Type	Indicates IP over Ethernet.
IP Address	IP address of the switch you are managing. The system supports SNMP over UDP/IP transport protocol. In this environment, all systems on the Internet, such as network interconnection devices and any PC accessing the agent module must have an IP address. Valid IP addresses consist of four numbers, of 0 to 255, and separated by periods. Anything outside of this format will not be accepted by the configuration program.
Subnet Mask	Subnet mask of the switch. This mask identifies the host address bits used for routing to specific subnets.
Gateway IP	Gateway used to pass trap messages from the system' s agent to the management station. Note that the gateway must be defined (when operating at Layer 2) if the management station is located in a different IP segment.
IP State	Specifies whether IP functionality is enabled via manual configuration, or set by Boot Protocol (BOOTP). Options include: USER-CONFIG - IP functionality is enabled based on the default or user specified IP Configuration. (This is the default setting.) BOOTP Get IP - IP is enabled but will not function until a BOOTP reply has been received. BOOTP requests will be periodically broadcasted by the switch in an effort to learn its IP address. (BOOTP values can include the IP address, default gateway, and subnet mask.)
VLAN ID	The VLAN used for management access when "Mgmt VLAN" is selected. See the next item.

Mgt. Access	Specifies which VLAN have access right to its management interface. Options include: All VLANs – All VLANs have access right to its management interface. (This is the default setting.) Mgmt VLAN – Only the specified VLAN have access right to its management interface
-------------	--

NOTE: When using multilayer mode, refer to “Subnet Configuration” on

5.6.2 Assigning SNMP Parameters

Use the SNMP Configuration screen to display and modify parameters for the Simple Network Management Protocol (SNMP). The switch includes an on-board SNMP agent which monitors the status of its hardware, as well as the traffic passing through its ports. A computer attached to the network, called a Network Management Station (NMS), can be used to access this information. Access rights to the agent module are controlled by community strings. To communicate with the switch, the NMS must first submit a valid community string for authentication. The options for configuring community strings and related trap functions are described in the following figures and table.

5.6.2.1 Configuring Community Names

The following figure and table describe how to configure the community strings authorized for management access. Up to 5 community names may be entered.

SNMP Communities		
Community Name	Access	Status
<input type="text" value="public"/>	Read Write ▾	Enabled ▾
<input type="text" value="private"/>	Read Only ▾	Enabled ▾
<input type="text"/>	Read Only ▾	Disabled ▾
<input type="text"/>	Read Only ▾	Disabled ▾
<input type="text"/>	Read Only ▾	Disabled ▾

Parameter	Description
Community Name	A community entry authorized for management access. (The maximum string length is 20 characters.)
Access	Management access is restricted to Read Only or Read/Write.
Status	Displays the administrative status of entry. An entry can only be to enabled or disabled via the console interface.

NOTE: WGS3-404 management interface is slightly different on this and other menus. It provide a "Edit" icon  to modify the parameter.

5.6.2.2 Configuring IP Trap Managers

The following figure and table describe how to specify management stations that will receive authentication failure messages or other trap messages from the switch. Up to 5 trap managers may be entered.

IP Trap Manager		
IP Address	Community Name	Status
<input type="text" value="0.0.0.0"/>	<input type="text"/>	Disabled ▾
<input type="text" value="0.0.0.0"/>	<input type="text"/>	Disabled ▾
<input type="text" value="0.0.0.0"/>	<input type="text"/>	Disabled ▾
<input type="text" value="0.0.0.0"/>	<input type="text"/>	Disabled ▾
<input type="text" value="0.0.0.0"/>	<input type="text"/>	Disabled ▾

Parameter	Description
IP Address	IP address of the trap manager.
Community Name	A community authorized to receive trap messages.
Status	Displays the administrative status of entry. An entry can only be to enabled or disabled via the console interface.

5.6.3 User Login Configuration

Use the User Configuration screen to restrict management access based on user names and passwords. The default administrator (admin) has write access for parameters governing the on-board agent. You should therefore assign a password to the administrator as soon as possible, and store it in a safe place.

5.6.3.1 Displaying the Current User Configuration

Use this menu to display the names and access rights for people authorized to manage the switch.

User Configuration					
User Name	User Password	Access Right	Console	Telnet	HTTP
guest	*****	guest	<input type="checkbox"/> Enabled	<input type="checkbox"/> Enabled	<input checked="" type="checkbox"/> Enabled
admin	*****	admin	<input checked="" type="checkbox"/> Enabled	<input checked="" type="checkbox"/> Enabled	<input checked="" type="checkbox"/> Enabled
		guest	<input type="checkbox"/> Enabled	<input type="checkbox"/> Enabled	<input type="checkbox"/> Enabled
		guest	<input type="checkbox"/> Enabled	<input type="checkbox"/> Enabled	<input type="checkbox"/> Enabled
		guest	<input type="checkbox"/> Enabled	<input type="checkbox"/> Enabled	<input type="checkbox"/> Enabled

Apply Cancel

Parameter	Description
User Name*	Specifies a user authorized management access to the switch via the console, Telnet or HTTP. An entry can only be deleted via the console interface.
User Password*	Password associated with this entry.
Access Right	ADMIN: Read/Write for all screens. GUEST: Read Only for all screens.
Console	Authorizes management via the console.
Telnet	Authorizes management via Telnet.
HTTP	Authorizes management via HTTP.

*These entries can consist of up to 15 alphanumeric characters and are not case sensitive.

5.6.4 Downloading System Software

Use the TFTP Download menu to load software updates to permanent flash ROM in the switch. The download file should be a binary file or an image file; otherwise the agent will not accept it. The success of the download operation depends on the accessibility of the TFTP server and the quality of the network connection. After downloading the new software, the agent will automatically restart itself. Parameters shown on this screen are indicated in the following figure and table

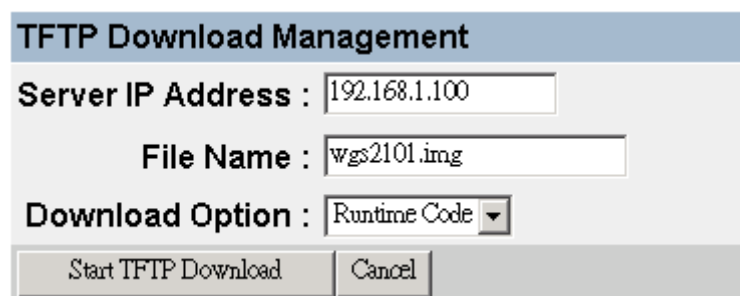

TFTP Download Management

Server IP Address : 192.168.1.100

File Name : wgs2101.img

Download Option : Runtime Code

Start TFTP Download Cancel

Parameter	Description
Server IP Address	IP address of a TFTP server.
File Name	The binary file or image file to download.
Download Option *	Specify the file to be Runtime Code or POST Code
Start TFTP Download	Issues request to TFTP server to download the specified file.

NOTE: WGS3-404 does not need to specify this option.

5.6.5 Saving or Restoring the System Configuration

Use the Configuration File menu to save the switch configuration settings to a file on a TFTP client. The file can be later downloaded to the switch to restore the switch's settings. The success of the operation depends on the accessibility of the TFTP client and the quality of the network connection. Parameters shown on this screen are indicated in the following figure and table.

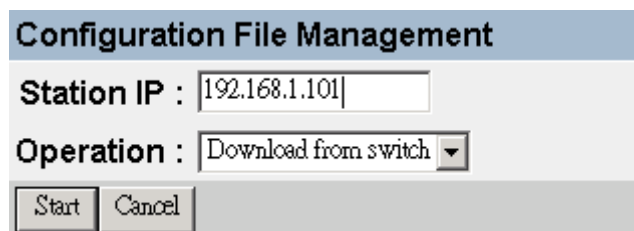

Configuration File Management

Station IP : 192.168.1.101

Operation : Download from switch

Start Cancel

Parameter Description

Parameter	Description
Station IP	IP address of a PC running TFTP client software.
Operation	Download from switch – Downloads the current switch configuration to a file on the client PC. Upload to switch – Uploads a configuration file to the switch from the client PC.

NOTE: Saving and restoring switch configuration settings can then be initiated by using any TFTP client utility, such as the command line utility included in Windows NT/2000/XP. For example, using Windows NT, from a DOS window command prompt, enter the TFTP command in the form:

```
TFTP [-i] host [GET : PUT] source [destination]
```

To transfer a file –

On Switch: Specify the IP address of the TFTP client, and select “Download from switch” or “Upload to Switch.” Then select <Start> from the menu to start.

On TFTP Client: Set the mode to <binary>, specify the IP address of the target switch and the directory path / name of the file to transfer. Then start transferring the configuration from the TFTP client or the switch and wait until the transfer completes.

For example, type “tftp -i 203.70.249.118 GET source wgs3.txt” on Windows 2000's command prompt to download switch's configuration and type “tftp -i 203.70.249.118 PUT wgs3.txt” to upload the configuration file to switch.

5.7 Device Control Menu

The Device Control menu is used to control a broad range of functions, including port mode, port mirroring, port trunking, Spanning Tree, Virtual LANs, IP subnets, multicast filtering, and routing protocols. Each of the setup screens provided by these configuration menus is described in the following sections.

Menu	Description
Layer 2 Menu	Configures port communication mode, mirror ports, port trunking, and static addresses.
Bridge Menu	Configures the Spanning Tree Protocol for the bridge or for specific ports, GMRP and GVRP for automatic registration of multicast and VLAN groups, traffic class priority threshold, and address aging time.
VLAN Menu	Configures VLAN settings for specific ports, and defines the port membership for VLAN groups.
IGMP Snooping Configuration ^{*1}	Configures IGMP multicast filtering.
IP Menu2	Configures the subnets for each VLAN group, global configuration for ARP and Proxy ARP, unicast and multicast protocols, static ARP table entries, static routes and the default route.
Security Menu	Configures MAC and IP ^{*2} Address filtering.

1: Only displayed for Layer 2 mode of WGS3-2620.

2: Only displayed for WGS3-404 and multilayer mode of WGS3-2620.









5.7.1 Layer 2 Menu

The Layer 2 menu contains options for port configuration, port mirroring, and port trunking. These menu options are described in the following sections.

Menu	Description
Port Configuration	Enables any port, enables/disables flow control, and sets communication mode to auto-negotiation, full duplex or half duplex.
Mirror Port Configuration	Sets the source and target ports for mirroring.
Port Trunking Configuration	Specifies ports to group into aggregate trunks.
Static Unicast Address Table	Used to manually configure host MAC addresses in the unicast table.
Static Multicast Address Table	Used to manually configure host MAC addresses in the multicast table.

5.7.1.1 Configuring Port Parameters

Use the Port Configuration menu to display and Edit icon to set communication parameters for any port on the switch, including administrative status, auto-negotiation, default communication speed and duplex mode, as well as flow control in use.

Port Configuration								
Port	Link Status	Admin Status	Auto Negotiate	Default Type	Current Control	Flow Control	Jack Type	Edit
1	✘	Enabled	Enabled	10M-Half-Duplex	10M-Half-Duplex	Off	RJ-45	
2	✘	Enabled	Enabled	10M-Half-Duplex	10M-Half-Duplex	Off	RJ-45	
3	✘	Enabled	Enabled	10M-Half-Duplex	10M-Half-Duplex	Off	RJ-45	
4	✘	Enabled	Enabled	10M-Half-Duplex	10M-Half-Duplex	Off	RJ-45	
5	✘	Enabled	Enabled	10M-Half-Duplex	10M-Half-Duplex	Off	RJ-45	
6	✘	Enabled	Enabled	10M-Half-Duplex	10M-Half-Duplex	Off	RJ-45	
7	✘	Enabled	Enabled	10M-Half-Duplex	10M-Half-Duplex	Off	RJ-45	
8	✘	Enabled	Enabled	10M-Half-Duplex	10M-Half-Duplex	Off	RJ-45	
9	✘	Enabled	Enabled	10M-Half-Duplex	10M-Half-Duplex	Off	RJ-45	

Click , the following table will be show to allow setting each port's parameter.

Edit Port Configuration

Port 1

Link Status: Off

Admin Status:

Auto Negotiate:

Default Type:

Current Type: 10M-Half-Duplex

Flow Control:

Jack Type: RJ-45

Parameter	Default	Description
Link Status		Indicates if the port has a valid connection to an external device.
Admin Status	Enabled	Allows you to disable a port due to abnormal behavior (e.g., excessive collisions), and then re-enable it after the problem has been resolved. You may also disable a port for security reasons.
Auto Negotiate	Enabled	Enables or disables auto-negotiation for the switch to find a optimum connection speed.
Default Type	10M-Half-Duplex	If auto-negotiation is disabled, the port will be set to the indicated speed and duplex mode.
Current		Type Indicates the current speed and duplex mode.
Flow Control	Disabled	Used to enable or disable flow control. Flow control can eliminate frame loss by "blocking" traffic from end stations or segments connected directly to the switch when its buffers fill. When enabled, back pressure is used for half-duplex and IEEE 802.3x for full-duplex. Note that flow control should not be used if a port is connected to a hub.
Jack Type	SC or RJ-45	Shows the jack type for each port.
Edit		Click  to edit communication parameters.

5.7.1.2 Using Port Mirror for Analysis

You can mirror traffic from any source port to a target port for real-time analysis. You can then attach a packet analyzer or RMON probe to the target port and study the traffic crossing the source port in a completely unobtrusive manner. When mirroring port traffic, note that the target port must be included in the same VLAN as the source port. (See “5.7.3.2 VLAN Table Configuration”)

5.7.1.2.1 Using Port Mirroring on WGS3-2620

On WGS3-2602, you can use the Mirror Configuration screen to mirror one or more ports to the monitor port as shown below.

Parameter	Description
Enable	Port Mirror Enables or disables the mirror function.
TX Mirrored Port	The port whose transmitted traffic will be mirrored.
TX Monitored Port	The port that will duplicate the transmitted traffic appearing on the mirrored port.
RX Mirrored Port	The port whose received traffic will be mirrored.
RX Monitored Port	The port that will duplicate the received traffic appearing on the mirrored port

NOTE: You can mirror multiple ports to a single port to view traffic such as that crossing a port trunk. However, note that some packets may be dropped for moderate to heavy loading.

5.7.1.2.2 Using Port Mirroring on WGS3-404

On WGS3-404, the monitor port have to be on port 8.

The screenshot shows a configuration page for port mirroring. At the top, there is a header "Enable Port Mirroring" with an unchecked checkbox. Below this, the "Mirroring mode" is set to "RX_Mode" via a dropdown menu. The "Mirror Port" is set to "1" via a dropdown menu. The "Monitor Port" is displayed as "8". At the bottom of the form, there are two buttons: "Save" and "Reset".

Parameter	Description
Enable Port Mirroring	Port Mirror Enables or disables the mirror function.
Mirroring Mode	Specify the outbound (TX_Mode) or inbound (RX_mode) packets for mirroring.
Mirror Port	Specify the port to be monitored
Monitor Port	The port whose used to attached computer with packet analyzer software.

5.7.1.3 Configuring Port Trunks

Ports can be combined into an aggregate link to increase the bandwidth of a network connection or ensure fault recovery. You can configure trunks between any two switches. The ports on this switch can be grouped into a trunk consisting of two, four or eight ports, creating an aggregate bandwidth to 400, 800, 1600, 4000 or 8000 Mbps when operating at full duplex. Besides balancing the load across each port in the trunk, the additional ports provide redundancy by taking over the load if another port in the trunk should fail. However, before making any physical connections between devices, use the Port Trunking Configuration menu to specify the trunk on the devices at both ends. When using a port trunk, remember that::

- The ports that can be assigned to the same trunk on WGS3-2620 are listed below:

Two ports as a trunk

<<13, 01>> <<14, 02>> <<15, 03>> <<16, 04>>
<<17, 05>> <<18, 06>> <<19, 07>> <<20, 08>>
<<21, 09>> <<22, 10>> <<23, 11>> <<24, 12>>

Four ports as a trunk

<<13, 01, 14, 02>> <<15, 03, 16, 04>>
<<17, 05, 18, 06>> <<19, 07, 20, 08>>
<<21, 09, 22, 10>> <<23, 11, 24, 12>>

Eight ports as a trunk

<<13, 01, 14, 02, 15, 03, 16, 04>>
<<17, 05, 18, 06, 19, 07, 20, 08>>
<<21, 09, 22, 10, 23, 11, 24, 12>>

Gigabit Ethernet Ports as a trunk

<<25, 26>>

- The ports that can be assigned to the same trunk on WGS3-404 are listed below:

Two ports as a trunk

<<1, 2>> <<3, 4>> <<5, 6>> <<7, 8>>

Four ports as a trunk

<<1, 2, 3, 4>> <<5, 6, 7, 8>>

- Ports can only be assigned to one trunk.
- The ports at both ends of a connection must be configured as trunk ports.
- The ports at both ends of a trunk must be configured in an identical manner, including communication mode, and VLAN assignments.
- None of the ports in a trunk can be configured as a mirror or monitor port.
- All the ports in a trunk have to be treated as a whole when moved from/to, added or deleted from a VLAN.
- The Spanning Tree Algorithm will treat all the ports in a trunk as a whole.
- Enable the trunk prior to connecting any cable between the switches to avoid creating a loop.

Use the Trunk Configuration screen to set up port trunks as shown below:

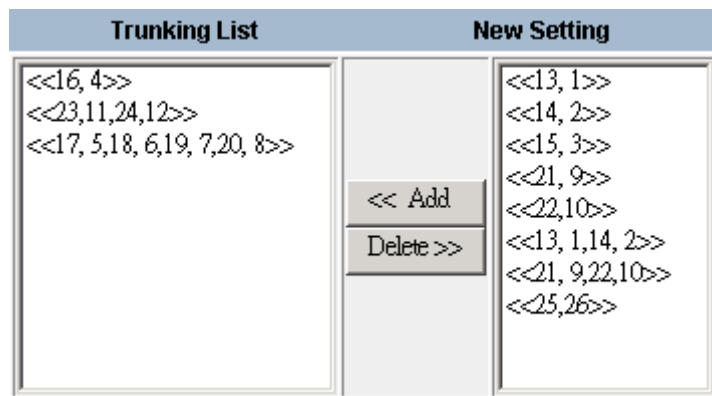

Parameter	Description
Trunk List	The port groups currently configured as trunks.
New Setting	The port groups that can still be configured as trunks.

To add a trunk, highlight a port group in the New Setting list and press Add. To delete a trunk, highlight a port group in the Trunk List and press Delete. Before disconnecting a port trunk, take the following steps:

Before removing a port trunk via the configuration menu, you must disable all the ports in the trunk or remove all the network cables. Otherwise, a loop may be created.

To disable a single link within a port trunk, you should first remove the network cable, and then disable both ends of the link via the configuration menu. This allows the traffic passing across that link to be automatically distributed to the other links in the trunk, without losing any significant amount of traffic.

5.7.1.4 Static Unicast Address Table

The Static Unicast Address Table can be used to assign the MAC address for a host device to a specific port on this switch. Static unicast addresses are never aged out, and cannot be learned by another port. If any packets with a source address specified in this table enter another port, they will be dropped. The Static Unicast Address Table is described in the following figure and table.

Static Unicast Address Configuration		
MAC Address	Port	Edit
303030-303030	1	

MAC :	<input type="text"/>	Port :	<input type="text" value="1"/>
<input type="button" value="Apply"/> <input type="button" value="Delete"/> <input type="button" value="Cancel"/>			

Parameter	Description
MAC Address	The MAC address of a host device attached to this switch.
Port	The port to which the host device is attached.

NOTE: To assign an address to a specific port, enter it in the MAC Address field, select the corresponding port, and press Save. To delete an address, click  and press Delete for the required entry.



5.7.1.5 Configuring the Static Multicast Address Table

The Static Multicast Address Table can be used to assign a destination MAC address (and the corresponding ports) to the VLAN group used for a specific multicast service. Static multicast addresses are never aged out, and traffic with these addresses can be forwarded only to ports specified in this table.

Multicast Address Configuration			
MAC Address	VLAN	Port	Edit
616060-606060	1	2	

Entry List							
MAC Address:	<input type="text"/>						
VLAN:	<input type="text"/>						
Port:	<input type="checkbox"/> 1	<input type="checkbox"/> 2	<input type="checkbox"/> 3	<input type="checkbox"/> 4	<input type="checkbox"/> 5	<input type="checkbox"/> 6	<input type="checkbox"/> 7
	<input type="checkbox"/> 8	<input type="checkbox"/> 9	<input type="checkbox"/> 10	<input type="checkbox"/> 11	<input type="checkbox"/> 12	<input type="checkbox"/> 13	<input type="checkbox"/> 14
	<input type="checkbox"/> 15	<input type="checkbox"/> 16	<input type="checkbox"/> 17	<input type="checkbox"/> 18	<input type="checkbox"/> 19	<input type="checkbox"/> 20	<input type="checkbox"/> 21
	<input type="checkbox"/> 22	<input type="checkbox"/> 23	<input type="checkbox"/> 24	<input type="checkbox"/> 25	<input type="checkbox"/> 26		
<input type="button" value="Apply"/> <input type="button" value="Delete"/> <input type="button" value="Cancel"/>							

Parameter	Description
MAC Address	The destination MAC address for a multicast service.
VLAN	The VLAN corresponding to this multicast service.
Port.	The ports to which this multicast traffic can be forwarded

NOTE: To assign a destination MAC address to one or more ports, enter its address and the corresponding VLAN, select the required ports, and then press Apply. To delete an address, click  and press Delete for the required entry. To modify an address, press  for the required entry to copy the configuration to the edit fields, make any necessary changes, then press Apply.

5.7.2 Using the Bridge Menu

The Bridge menu is used to configure settings for the Spanning Tree Algorithm, as well as the global bridge settings for GMRP (GARP Multicast Registration Protocol) and GVRP (GARP VLAN Registration Protocol), traffic classes priority threshold, and address aging time.

The Spanning Tree Algorithm can be used to detect and disable network loops, and to provide backup links between switches, bridges or routers. This allows the switch to interact with other bridging devices (that is, an STA-compliant switch, bridge or router) in your network to ensure that only one route exists between any two stations on the network, and provide backup links that automatically take over when a primary link goes down. For a more detailed description of how to use this algorithm, refer to “6.1.3 Spanning Tree Algorithm”.

Menu	Description
Bridge Configuration	Contains global bridge settings for STA (including bridge priority, hello time, forward delay, maximum message age), GMRP, GVRP, traffic class priority threshold, and address aging time.
STA Port Configuration	Contains STA settings for individual ports, including port priority, path cost, and fast forwarding

5.7.2.1 Configuring Global Bridge Settings

The following figure and table describe bridge configuration for STA, GMRP, GVRP, priority threshold, and address aging time.

Bridge Configuration

Spanning Tree: GMRP:

Bridge Priority: GVRP:

Hello Time (seconds): Priority Threshold:

Forward Delay (seconds): Aging Time (seconds): seconds

Maximum Age (seconds):

Parameter	Default	Description
Spanning Tree	Enabled	Enable this parameter to participate in a STA compliant network.
Bridge Priority	32,768	Bridge priority is used in selecting the root device, root port, and designated port. The device with the highest priority becomes the STA root device. However, if all devices have the same priority, the device

		with the lowest MAC address will then become the root device.
		Enter a value from 0 - 65535.
		Remember that the lower the numeric value, the higher the priority.
Hello Time	2	Time interval (in seconds) at which the root device transmits a configuration message.
		The minimum value is 1.
		The maximum value is the lower of 10 or
		$[(\text{Max. Message Age} / 2) - 1]$.
Forward Delay	15	The maximum time (in seconds) the root device will wait before changing states (that is, listening to learning to forwarding). This delay is required because every device must receive information about topology changes before it starts to forward frames. In addition, each port needs time to listen for conflicting information that would make it return to a blocking state; otherwise, temporary data loops might result.
		The maximum value is 30.
		The minimum value is the higher of 4 or
		$[(\text{Max. Message Age} / 2) + 1]$.
Max (Message) Age	20	The maximum time (in seconds) a device can wait without receiving a configuration message before attempting to reconfigure. All device ports (except for designated ports) should receive configuration messages at regular intervals. Any port that ages out STA information (provided in the last configuration message) becomes the designated port for the attached LAN. If it is a root port, a new root port is selected from among the device ports attached to the network.
		The minimum value is
		the higher of 6 or $[2 \times (\text{Hello Time} + 1)]$.
		The maximum value is
		the lower of 40 or $[2 \times (\text{Forward Delay} - 1)]$.
GMRP ¹	Disabled	GARP Multicast Registration Protocol (GMRP) allows network devices to register end stations with multicast groups. If GMRP is globally enabled for the switch, then you can individually enable or disable GMRP for a specific port. See "4.5.4.1 VLAN Port Configuration".
		IGMP and IGMP Snooping also provide multicast filtering. For multilayer mode, the full IGMP protocol set is automatically enabled/disabled along with DVMRP. (See "6.4.2 IGMP Protocol", and "4.5.5 Configuring IGMP Snooping".)
GVRP	Disabled	GARP VLAN Registration Protocol (GVRP) defines a way for switches to exchange VLAN information in order to register VLAN members on ports across the network. This function should be enabled to permit automatic VLAN registration, and to support VLANs which extend

		beyond the local switch.
		If GVRP is globally enabled for the switch, then you can individually enable or disable GVRP for a specific port. See “4.5.4.1 VLAN Port Configuration”.
Priority	4	WGS3-2620 supports Quality of Service (QoS) by using two priority queues, with Weighted Fair Queuing for each port. Up to 8 separate traffic classes are defined in IEEE 802.1p. So any packets with a priority equal to or higher than this threshold are placed in the high priority queue. You can use “4.5.4.1 VLAN Port Configuration” to configure the default priority for each port.
Threshold ¹		
High/Medium/ Low Priority ²	6/4/2	WGS3-404 supports Quality of Service (QoS) by using four priority queues (High, Medium, Low and Lowest), with Weighted Fair Queuing for each port. Up to 8 separate traffic classes are defined in IEEE 802.1p. So any packets with a priority equal to or higher than High Priority (default is 6) are placed in the high priority queue and so do others. Any packets with a priority lower than Low Priority (default is 2) are placed in the lowest priority queue. You can use “4.5.4.1 VLAN Port Configuration” to configure the default priority for each port.
Aging Time	300	Time-out period in seconds for aging out dynamically learned MAC addresses information.
		Range: 10 - 1000000 seconds

1: Only displayed on WGS3-2620.

2: Only displayed on WGS3-404

5.7.2.2 Configuring STA for Ports

The following figure and table describe port STA configuration.

STA Port Configuration				
Port	Type	Priority	Cost	FastForwarding
1	100BASE-TX	128	19	<input type="checkbox"/> Enabled
2	100BASE-TX	128	19	<input type="checkbox"/> Enabled
3	100BASE-TX	128	19	<input type="checkbox"/> Enabled
4	100BASE-TX	128	19	<input type="checkbox"/> Enabled
5	100BASE-TX	128	19	<input type="checkbox"/> Enabled
6	100BASE-TX	128	19	<input type="checkbox"/> Enabled
7	100BASE-TX	128	19	<input type="checkbox"/> Enabled
8	100BASE-TX	128	19	<input type="checkbox"/> Enabled
9	100BASE-TX	128	19	<input type="checkbox"/> Enabled
10	100BASE-TX	128	19	<input type="checkbox"/> Enabled

Parameter	Default	Description
Type		Shows port type as: 100TX : 10BASE-T / 100BASE-TX 1000T : 1000BASE-T 1000FX: 1000Base-SX or 1000Base-LX
Priority	128	Defines the priority for the use of a port in the STA algorithm. If the path cost for all ports on a switch are the same, the port with the highest priority (that is, lowest value) will be configured as an active link in the Spanning Tree. Where more than one port is assigned the highest priority, the port with lowest numeric identifier will be enabled. The range is 0 - 255.
(Path) Cost	100/19/4	This parameter is used by the STA algorithm to determine the best path between devices. Therefore, lower values should be assigned to ports attached to faster media, and higher values assigned to ports with slower media. (Path cost takes precedence over port priority.) The default and recommended range is: Ethernet: 100 (50~600) Fast Ethernet: 19 (10~60) Gigabit Ethernet: 4 (3~10) The full range is 0 - 65535.
Fast Forwarding	Disabled	This parameter is used to enable/disable the Fast Spanning Tree mode for the selected port. In this mode, ports skip the Blocked, Listening and Learning states and proceed straight to Forwarding.

NOTE: Since end-nodes cannot cause forwarding loops, they can pass through the Spanning Tree state changes more quickly than allowed by standard convergence time. Fast Forwarding can achieve quicker convergence for end-node workstations and servers, and also overcome other STA related timeout problems. (Remember that Fast Forwarding should only be enabled for ports connected to an end-node device.)

5.7.3 Configuring Virtual LANs

You can use the VLAN configuration menu to assign any port on the switch to any of up to 256 LAN groups. In conventional networks with routers, broadcast traffic is split up into separate domains. Switches do not inherently support broadcast domains. This can lead to broadcast storms in large networks that handle traffic such as IPX or NetBEUI. By using IEEE 802.1Q compliant VLANs, you can organize any group of network nodes into separate broadcast domains, thus confining broadcast traffic to the originating group. This also provides a more secure and cleaner network environment. For more information on how to use VLANs, see "6.3 Virtual LANs". The VLAN configuration screens are described in the following sections.

5.7.3.1 VLAN Port Configuration

You can use the VLAN Port Configuration screen to configure GARP, the default VLAN identifier, default port priority, VLAN tagging on outgoing frames, GVRP and GMRP status, and filtering for incoming frames for VLAN groups this port does not belong to.

Port Number : 1	
GARP Configuration	
Join Time	20 Centiseconds
Leave Time	60 Centiseconds
Leave All Time	1000 Centiseconds
VLAN and Priority	
Port VID	1
Port Default Priority	0
VLAN Tagging	Rx All, Tx Untag
GVRP	Enabled
GMRP	Enabled
Ingress Filtering	Disabled
<input type="button" value="Apply"/> <input type="button" value="Cancel"/>	

Parameter	Default	Description
GARP ^{*1}		Group Address Registration Protocol is used by GVRP and GMRP to register or deregister client attributes for client services within a bridged LAN.
Join Time	20	The interval (centiseconds) between transmitting requests/queries to participate in a group.

Leave Time	60	The interval (centiseconds) a port waits before leaving a group. This time should be set to more than twice the Join Time. This ensures that after a Leave or LeaveAll message has been issued, the applicants can re-join before the port actually leaves the group.
Leave All Time	1000	The interval (centiseconds) between sending out a LeaveAll query message for group participants and the port leaving the group. This interval should be considerably larger than the Leave Time to minimize the amount of traffic generated by nodes rejoining the group.

1: The default values for the GARP timers are independent of the media access method or data rate. These values should not be changed unless you are experiencing some difficulties with GMRP or GVRP registration/deregistration.

Parameter	Default	Description
VLAN and Priority		These fields set the default values for VLANs, port priority, GVRP and GMRP.
Port VID	1	The VLAN ID assigned to untagged frames received on this port.
Port Default Priority ^{*2}	0	Set the default ingress priority to any value beneath the priority threshold to specify the low priority queue, or to any value equal to or above this threshold to specify the high priority queue.
VLAN Tagging ^{*3}	Layer 2 - Rx All, Tx All	Indicates whether or not VLAN tags will be included on frames passing through this port. The options include: Rx All: Accepts all frames, tagged or untagged.
	Multilayer - Rx All, Tx Untag	Rx Untag: Only accepts untagged frames. Tx All: If PVID and frame tag are same, sends tagged frame, otherwise sends untagged. Tx Untag: Sends only untagged frames.

2: The switch supports Quality of Service (QoS) by using two or four priority queues, with Weighted Fair Queuing for each port. Inbound frames that do not have VLAN tags are tagged with the input port's default ingress user priority, and then placed in the appropriate priority queue at the output port. The default priority for all ingress ports is zero. Therefore, any inbound frames that do not have priority tags will be placed in the low priority queue of the output port. (Note that if the output port is an untagged member of the associated VLAN, these frames are stripped of all VLAN tags prior to transmission.)

3: If you want to create a small port-based VLAN for just one or two switches, you can assign ports to the same untagged VLAN (and use a separate connection where a VLAN crosses the switches). However, to participate in a VLAN group that extends beyond this switch, we recommend using the VLAN ID for that group (using VLAN tagging for Layer 2 mode, or a common PVID for multilayer mode).

When operating the switch in Layer 2 mode, ports assigned to a large VLAN group that crosses several switches must use VLAN tagging. But when operating in multilayer mode, this switch does not currently support tagging, so you should set the PVID to the same value at both ends of the link (if the device you

are attaching to is VLAN-aware), and configure an IP interface for this VLAN if you need to connect it to other group.

This parameter is for WGS3-2620 only. WGS3-404's default setting is Rx All and use VLAN Table Configuration for Tx.

Parameter	Default	Description
GVRP	Enabled	Enables or disables GVRP for this port. When disabled, any GVRP packets received on this port will be discarded and no GVRP registrations will be propagated from other ports. Note that GVRP must be enabled globally for the switch before this setting can take effect. (See "4.5.3.1 Configuring Global Bridge Settings")
GMRP ^{*4}	Enabled	Enables or disables GMRP for this port. When enabled, this port will allow end stations to register with multicast groups using GMRP. Note that GMRP must be enabled for the switch before this setting can take effect. IGMP and IGMP Snooping also provide multicast filtering. (See "6.4.2 IGMP Protocol")
Ingress Filtering ^{*5}	Disabled	If enabled, incoming frames for VLANs which do not include this ingress port in their member set will be discarded at the ingress port.

4: Only displayed on WGS3-2620.

5: This control does not affect VLAN independent BPDU frames, such as GVRP or STP. However, they do affect VLAN dependent BPDU frames, such as GMRP.

5.7.3.2 VLAN Table Configuration

Use this screen to create a new VLAN or modify the settings for an existing VLAN.

The VLAN Table Configuration of WGS3-2620 and WGS3-404 are slightly different. For WGS3-2620, the VLAN Table Configuration is as the following:

VLAN Table Configuration		N:Normal X:Forbidden S:Static R:Reg. Fixed																										
VLAN	1	2	3	4	5	6	7	8	9	10	11	12	13	14	15	16	17	18	19	20	21	22	23	24	25	26		
1	S	S	S	S	S	S	S	S	S	S	S	S	S	S	S	S	S	S	S	S	S	S	S	S	S	S	S	
2	S	N	N	N	N	N	N	N	N	N	N	N	N	N	N	N	N	N	N	N	N	N	N	N	N	N	N	
3	N	R	X	N	N	N	N	N	N	N	N	N	N	N	N	N	N	N	N	N	N	N	N	N	N	N	N	

VID:

N	X	R	S	1	N	X	R	S	2	N	X	R	S	3	N	X	R	S	4	N	X	R	S	5	N	X	R	S	6					
<input type="radio"/>	<input type="radio"/>	<input type="radio"/>	<input type="radio"/>		<input type="radio"/>	<input type="radio"/>	<input type="radio"/>	<input type="radio"/>		<input type="radio"/>	<input type="radio"/>	<input type="radio"/>	<input type="radio"/>		<input type="radio"/>	<input type="radio"/>	<input type="radio"/>	<input type="radio"/>		<input type="radio"/>	<input type="radio"/>	<input type="radio"/>	<input type="radio"/>		<input type="radio"/>	<input type="radio"/>	<input type="radio"/>	<input type="radio"/>		<input type="radio"/>	<input type="radio"/>	<input type="radio"/>	<input type="radio"/>	
<input type="radio"/>	<input type="radio"/>	<input type="radio"/>	<input type="radio"/>	7	<input type="radio"/>	<input type="radio"/>	<input type="radio"/>	<input type="radio"/>	8	<input type="radio"/>	<input type="radio"/>	<input type="radio"/>	<input type="radio"/>	9	<input type="radio"/>	<input type="radio"/>	<input type="radio"/>	<input type="radio"/>	10	<input type="radio"/>	<input type="radio"/>	<input type="radio"/>	<input type="radio"/>	11	<input type="radio"/>	<input type="radio"/>	<input type="radio"/>	<input type="radio"/>	12	<input type="radio"/>	<input type="radio"/>	<input type="radio"/>	<input type="radio"/>	13
<input type="radio"/>	<input type="radio"/>	<input type="radio"/>	<input type="radio"/>	14	<input type="radio"/>	<input type="radio"/>	<input type="radio"/>	<input type="radio"/>	15	<input type="radio"/>	<input type="radio"/>	<input type="radio"/>	<input type="radio"/>	16	<input type="radio"/>	<input type="radio"/>	<input type="radio"/>	<input type="radio"/>	17	<input type="radio"/>	<input type="radio"/>	<input type="radio"/>	<input type="radio"/>	18	<input type="radio"/>	<input type="radio"/>	<input type="radio"/>	<input type="radio"/>	19	<input type="radio"/>	<input type="radio"/>	<input type="radio"/>	<input type="radio"/>	20
<input type="radio"/>	<input type="radio"/>	<input type="radio"/>	<input type="radio"/>	21	<input type="radio"/>	<input type="radio"/>	<input type="radio"/>	<input type="radio"/>	22	<input type="radio"/>	<input type="radio"/>	<input type="radio"/>	<input type="radio"/>	23	<input type="radio"/>	<input type="radio"/>	<input type="radio"/>	<input type="radio"/>	24	<input type="radio"/>	<input type="radio"/>	<input type="radio"/>	<input type="radio"/>	25	<input type="radio"/>	<input type="radio"/>	<input type="radio"/>	<input type="radio"/>	26					

Parameter	Description
VLAN	The ID for the VLAN currently displayed. Range: 1-4094
(Port)	Port entries may be marked as: N : (Normal) Uses GVRP to determine port membership. S : (Static) Adds port as a static entry. GVRP protocol is disabled. R : (Registration Fixed) Adds port as a static entry. GVRP protocol messages are still forwarded through this port. X : (Forbidden) Disables GVRP for this VLAN on the specified port. If a removed port is no longer assigned to any other group as an untagged port, it will automatically be assigned to VLAN group 1 as untagged.

Note: To add a new VLAN, enter a new VLAN number in the VID field, select the port members, and press Add/Save. To modify a VLAN, click on the edit icon () for the required entry, modify the port settings, and press Add/Save. To delete a VLAN, click on the edit icon () for the required entry then press Delete.

The VLAN Table Configuration of WGS3-404 is as the following:

VLAN Table Configuration																		
N:Normal X:Forbidden S:Static R:Reg. Fixed U:UnTag T:Tag																		
VLAN	MEMBER								UNTAG									
VLAN	1	2	3	4	5	6	7	8		1	2	3	4	5	6	7	8	Edit
1	S	S	S	S	-	S	S	S	-	U	U	U	U	-	U	U	U	
Add New Entry																		

Click Edit icon, the following screen will be shown.

VID :

N	X	R	S	T	U	N	X	R	S	T	U	N	X	R	S	T	U	N	X	R	S	T	U
<input type="radio"/>	<input type="radio"/>	<input type="radio"/>	<input checked="" type="radio"/>	<input type="radio"/>	<input checked="" type="radio"/>	<input type="radio"/>	<input type="radio"/>	<input type="radio"/>	<input checked="" type="radio"/>	<input type="radio"/>	<input checked="" type="radio"/>	<input type="radio"/>	<input type="radio"/>	<input type="radio"/>	<input checked="" type="radio"/>	<input type="radio"/>	<input checked="" type="radio"/>	<input type="radio"/>	<input type="radio"/>	<input type="radio"/>	<input checked="" type="radio"/>	<input type="radio"/>	<input checked="" type="radio"/>
1						2						3						4					
5						6						7						8					

Parameter	Description
VLAN	The ID for the VLAN currently displayed. Range: 1-4094
MEMBERS	Port entries may be marked as: - : (Normal) Uses GVRP to determine port membership. S : (Static) Adds port as a static entry. GVRP protocol is disabled. R : (Registration Fixed) Adds port as a static entry. GVRP protocol messages are still forwarded through this port. X : (Forbidden) Disables GVRP for this VLAN on the specified port. If a removed port is no longer assigned to any other group as an untagged port, it will automatically be assigned to VLAN group 1 as untagged.
UNTAG	Specify the outbound packets for this VLAN on this port should be tagged or untagged. U: The outbound packets for this VLAN on this port should be untagged. T: The outbound packets for this VLAN on this port should be tagged.

5.7.3.3 Reset Address Table Mode

WGS3-404 provide two address table modes, SVL (Shared VLAN Learning) and IVL (Independent VLAN Learning).

SVL: Configuration and operation of the MAC address learning process with the same MAC address table for all VLANs. If an individual MAC Address is learned in one VLAN, that learned information is used in forwarding decisions taken for that address relative to all other VLANs. SVL is suitable when you need to have asymmetric VLANs. Under normal circumstances, a pair of devices communicating in a VLAN environment will both send and receive using the same VLAN. However, there are some circumstances in which it is convenient to make use of two distinct VLANs, one used for A to transmit to B: the other used for B to transmit to A.

IVL: Configuration and operation of the MAC address learning process with difference MAC address table for all VLANs. If a given individual MAC Address is learned in one VLAN, that learned information is not used in forwarding decisions taken for that address relative to any other VLAN. IVL is suitable when two or more VLANs are connected by a bridge(switch) or there are duplicate MAC addresses on different VLANs.

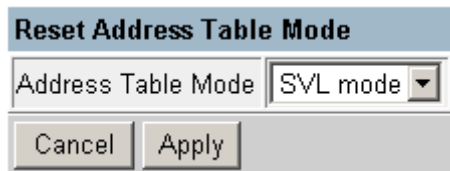

Parameter	Default	Description
Reset Address Table Mode	SVL	Specify the address table mode to be SVL or IVL.

5.7.4 Configuring IGMP Snooping

This option is displayed on Device Control Menu for Layer 2 mode of WGS3-2620 and on Protocol Configuration Menu (under Device Control Menu -> IP Menu) for Layer 3 mode of WGS3-2620 or WGS3-404. Multicasting is used to support real-time applications such as video conferencing or streaming audio. A multicast server does not have to establish a separate connection with each client. It merely broadcasts its service to the network; and any hosts which want to receive the multicast register with their local multicast switch/router. Although this approach reduces the network overhead required by a multicast server, the broadcast traffic must be carefully pruned at every multicast switch/router it passes through to ensure that traffic is only passed on to the hosts which subscribed to this service.

This switch uses IGMP (Internet Group Management Protocol) Snooping to monitor any attached hosts which want to receive a specific multicast service. It looks up the IP Multicast Group used for this service, and adds any port which received a similar request to that group.

You can use the IGMP Snooping Configuration screen to configure multicast filtering shown below.

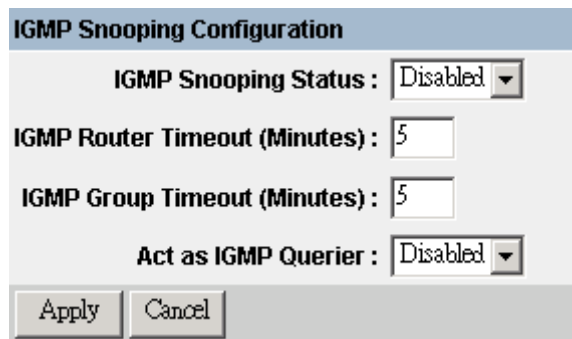

IGMP Snooping Configuration

IGMP Snooping Status :

IGMP Router Timeout (Minutes) :

IGMP Group Timeout (Minutes) :

Act as IGMP Querier :

Parameter	Default	Description
IGMP Snooping Status ¹	Disabled	If enabled, the switch will monitor network traffic to determine which hosts want to receive multicast traffic. This is also referred to as IGMP Snooping.
IGMP Router Timeout	5	A switch port that stops receiving multicast protocol packets for this interval will be removed from the IGMP forwarding list. Range: 3 - 5 minutes
IGMP Group Timeout	5	The time between spotting an IGMP Report message for an IP multicast address on a specific port before the switch removes that entry from its list. Range: 3 - 5 minutes
Act as IGMP Querier ²	Disabled	If enabled, the switch can serve as the “querier,” which is responsible for asking hosts if they want to receive multicast traffic.

1: This item is only displayed for Layer 2 mode of WGS3-2620. For WGS3-404 and multilayer mode of WGS3-2620, the full IGMP protocol set is automatically enabled/disabled along with DVMRP. (See “6.4 Multicast Filtering” and “4.5.6.1.5 Configuring DVMRP”.)

2: This item is only displayed for Layer 2 mode of WGS3-2620. When IGMP is enabled for WGS3-404 and multilayer mode of WGS3-2620, the switch will always serve as the querier if elected.

5.7.5 Configuring IP Settings

If this switch is WGS3-404 or WGS3-2620 in multilayer mode, the IP Menu will be displayed.

Use this menu to configure the IP subnets for each VLAN on your switch, the unicast and multicast routing protocols, static ARP entries, static IP routes, and the default IP route.

Parameter	Description
Subnet Configuration	IP Subnet Configuration – Specifies the IP interface for VLANs configured on this switch, including the subnet address and routing protocols. Port Group Configuration – See “5.7.3.2 VLAN Table Configuration”.
Protocol Configuration	Configures ARP timeout, enables Proxy ARP, sets the preferred servers for BOOTP/DHCP Relay, as well as enabling/configuring unicast and multicast protocols globally for this switch.
Static ARP Configuration	Used to map an IP address to a specific physical MAC address.
Static Route	Used to configure static routes to other IP networks, subnetworks, or hosts.
Default Route	Defines the router to which this switch will forward all traffic for unknown networks.

5.7.5.1 Subnet Configuration

Use this menu to specify an IP interface for any VLAN configured on this switch that needs to communicate with a device outside of its own group (that is, another network segment). You also need to define a VLAN for each IP subnet connected directly to this switch. Note that you must first create a VLAN as described under “5.7.3 Configuring Virtual LANs” before configuring the corresponding subnet.

IP Subnet Configuration							
Destination Network	Subnet Mask	VLAN	Proxy Arp	RIP	OSPF	DVMRP	Edit
192.168.1.254	255.255.255.0	1	✗	✗	✓	✗	
Add New Entry							

Edit IP Subnet Configuration

Destination Network:

Subnet Mask:

VLAN:

Proxy Arp:

RIP:

OSPF:

DVMRP:

Parameter	Description
IP Address	The IP address associated with the specified VLAN interface. In general, it is the router IP address for the specified VLAN members.
Subnet Mask	A template that identifies the address bits in the host address used for routing to specific subnets. Each bit that corresponds to a “1” is part of the network / subnet number; and each bit that corresponds to “0” is part of the host number.
VLAN	The VLAN associated with this IP interface.
Proxy ARP	Enables or disables Proxy ARP for the interface. This feature allows the switch forward an ARP request from a node in the attached subnetwork (that does not have routing or a default gateway configured) to a remote subnetwork. (See “6.2.5 Proxy ARP”) Note that Proxy ARP must be enabled globally for the switch before this setting can take effect. (See “5.7.5.2 Protocol Configuration”.)
RIP	Routing Information Protocol for unicast routing.
OSPF	Open Shortest Path First unicast routing protocol.
DVMRP	Distance-Vector Multicast Routing Protocol.

5.7.5.1.1 Adding an IP Interface

To add an IP interface, specify the interface settings in the dialog box at the bottom of the screen. Configure the IP address, assign an existing VLAN group to this interface, enable the required routing protocols, and then press Add. To configure the unicast and multicast routing protocols, you must edit an existing entry (as described in the following section) and press the Advanced button for RIP or DVMRP.

5.7.5.1.2 Modifying an IP Interface

To modify an IP interface, click on the edit icon (✎) for the required entry, update the interface settings in the dialog box at the bottom of the screen, use the Advanced button to configure the unicast and multicast routing protocols (as described in the following sections), and then press Save.

5.7.5.1.3 Configuring RIP

The Routing Information Protocol is used to specify how routers exchange routing table information. (See “6.2.6.1 RIP and RIP-2 Dynamic Routing Protocols”.)

When RIP is enabled on this routing switch, it broadcasts RIP messages to all devices in the network every 30 seconds, and updates its own routing table when RIP messages are received from other routers. RIP messages contain both the IP address and a metric for each destination network it knows about, and the metric indicates the number of hops from this device to the destination network.

You can use the following menu to specify authentication, the protocol used for sending or receiving routing messages on this port, the default metric used in calculating the best path, and enable or disable Poison Reverse.

Modify RIP Configuration

Authentication Type : No Authentication ▾

Authentication Key :

Send Type : RIPv1 Broadcast ▾

Receive Type : RIPv1 ▾

Default Metric :

Poison Reverse : Enabled ▾

Save Reset Cancel

Parameter	Description
Authentication Type	Authentication can be used to ensure that routing information comes from a valid source.
Authentication Key	A simple password must be provided if authentication is enabled. (An authentication string is case sensitive, and can be up to 16 characters.)
Send Type	The protocol used for traffic sent out this port: RIP1 Broadcast: Route information is broadcast to other routers on the network using RIPv1. RIP2 Broadcast: Route information is broadcast to other routers on the network using RIPv2. RIP2 Multicast: Route information is multicast to other routers on the network using RIPv2. Do Not Send: The switch will passively monitor route information advertised by other routers attached to the network.
Receive Type	The routing protocol messages accepted on this port includes RIP1, RIP2, RIP1/RIP2, or Do Not Receive.
Default Metric	A "metric" indicates the number of hops between the switch and the destination network. The "default metric" is used for the default route in RIP updates originated on this interface. A value of zero indicates that no default route should be originated; in this case, a default route via another router may be propagated. Range: 0-15
Poison Reverse*	Directs routes back to an interface port from which they have been acquired, but sets the distance vector metrics to infinity.

* This is a method of preventing routing information from looping back to the source. Note that Split Horizon is also enabled on this switch for this purpose. (See "6.2.6.1 RIP and RIP-2 Dynamic Routing Protocols".)

5.7.5.1.4 Configuring OSPF

Open Shortest Path First is more suited for large area networks which experience frequent changes in the links. It also allows for subnets. This protocol actively tests the status of each link to its neighbors to generate a shortest path tree, and builds a routing table based on this information. OSPF then utilizes IP multicast to propagate routing information. A separate routing area scheme is also used to further reduce the amount of routing traffic. You can use the following menu to specify the area identifier, or other key routing parameters as described in the following table.

Parameter	Default	Description
Area ID ^{*1}	0.0.0.0	A 32-bit integer uniquely identifying an OSPF protocol broadcast area. This identifier can be in the form of an IP address or integer. Each port on the switch can be configured to represent one OSPF area. You must first specify OSPF areas for global access in the Area ID Configuration menu, before they can be used for a specific IP interface. ID 0.0.0.0 is used for the OSPF backbone.
Router Priority	1	The priority used when selecting the designated router and designated backup router. Range: 0-255; Disable election: 0
Interface Cost	100	Explicitly specify the cost of sending a packet on the interface. Range: 1-65535

Transit Delay	1 second	<p>The estimated number of seconds it takes to transmit a link state update packet over this interface.</p> <p>Range: 0-3600 seconds</p>
Retransmit Interval	5 seconds	<p>The number of seconds between retransmitting link-state advertisements to router adjacencies on this interface. This value is also used when retransmitting database descriptions and link-state request packets.</p> <p>Range: 0-3600 seconds</p>
Hello Interval ^{*2}	10 seconds	<p>The interval, in seconds, between sending Hello packets out the router interface. This interval determines how fast topology changes will be detected. However, for small intervals, more overhead will be incurred in exchanging routing information.</p> <p>Range: 1-65535 seconds</p>
Dead Interval ^{*2}	40 seconds	<p>The number of seconds that a router's Hello packets have not been seen before its neighbors declare the router down. This should be a multiple of the Hello interval.</p> <p>Range: 1-65535 seconds</p>
Poll Interval	120 seconds	<p>Sets the poll interval (in seconds) for this interface. If a neighboring router has become inactive (Hello Packets have not been seen for Router Dead Interval), then it may still be necessary to send Hello Packets to the dead neighbor. These Hello Packets are sent at the reduced rate which should be much larger than Hello Interval. The default is 120 seconds.</p>
Authentication Type NONE		<p>Use this option to specify how to authenticate neighboring OSPF routers. There are three options:</p> <p>NONE: Not to authenticate neighboring routers.</p> <p>SIMPLE: Use password to authenticate neighboring OSPF routers. The password is assigned on Authentication Key field. With SIMPLE authentication, the password goes in clear-text over the network. Thus, anyone with a sniffer software on the OSPF network segment would be able to pull the OSPF password, and the network attacker would be one step closer to compromising your OSPF environment.</p> <p>MD5: Use MD5 to authenticate neighboring routers. With MD5 authentication, the key does not pass over the network. MD5 is a message-digest algorithm specified in RFC1321. MD5 should be considered the most secure OSPF authentication mode. You have to specify an active MD5 key on MD5 Key Table.</p>
Authentication Key		<p>When use SIMPLE authentication type, enter the password here. The password can be any string of keyboard-entered characters up to 8 bytes in length. All neighboring routers on the same network must have the same password to exchange OSPF information.</p>

MD5 Key Table

When use MD5 authentication mode, you have to specify an active MD5 key on this table. Up to 8 key can be added on the table but only one can be **Active**. The others should be left to be **Valid**. To remove the key, set the status to be **Invalid** and select <Apply>. Each key consists of two parameters:

Key ID : An identifier from 1 to 255.

Key : An alphanumeric password of up to 16 bytes.

1: The Area ID is used to specify a group of contiguous networks and hosts. OSPF protocol broadcast messages are restricted by area to limit their impact on network performance.

2: This value must be the same for all routers attached to a common network.

5.7.5.1.5 Configuring DVMRP

Distance Vector Multicast Routing Protocol is used to route multicast traffic to nodes which have requested a specific multicast service via IGMP. (See "6.4.4 DVMRP Routing Protocol".) To configure DVMRP, you must specify the routing metric, probe interval, and neighbor router timeout.

Parameter	Default	Description
Metrics	1 hop	This value is used to select the best reverse path to networks that are connected directly to an interface on this switch. Range: 1-31 hops
Probe Interval	10 seconds	The interval between sending neighbor probe messages to the multicast group address for all DVMRP routers. Range: 5-30 seconds
Neighbor Timeout	35 seconds	The interval to wait without hearing from a DVMRP neighbor before declaring it dead. This is used for timing out routes, and for setting the children and leaf flags. Range: 10-8000 seconds

NOTE: IGMP is automatically enabled/disabled along with DVMRP. (See "6.4.2 IGMP Protocol".)

5.7.5.2 Protocol Configuration

Use the Protocol Configuration screen to globally enable or disable unicast or multicast routing protocols for the switch.

Protocol Configuration		
ARP		Advanced >>
Proxy ARP	Disabled ▾	
RIP	Disabled ▾	Advanced >>
OSPF	Enabled ▾	
DHCP Relay	Disabled ▾	Advanced >>
IGMP Snooping	Disabled ▾	Advanced >>
DVMRP	Disabled ▾	
Cancel Apply		

Parameter	Description
ARP	Sets the aging time for dynamic ARP entries.
Proxy ARP	<p>Enables or disables Proxy ARP globally for the switch. This feature allows the switch to forward an ARP request from a node in the attached subnetwork (that does not have routing or a default gateway configured) to a remote subnetwork. (See “6.2.5 Proxy ARP”.)</p> <p>If Proxy ARP is globally enabled for the switch, then you can enable or disable it for a specific interface. See “4.5.6.1.1 Adding an IP Interface”, or “4.5.6.1.3 Modifying an IP Interface”.</p>
RIP	Enables or disables the Routing Information Protocol. The Advanced menu sets the interval at which the switch advertises known routes, and also enables/disables advertising for static routes or the default route.
OSPF	Enables or disables the OSPF routing protocol. The Advanced menu organizes an autonomous system into normal, stub, or not so stubby areas; configures a range of subnet addresses for which link state advertisements can be aggregated; and configures virtual links for areas that do not have direct physical access to the OSPF backbone, to add redundancy, or to merge backbone areas.
DHCP Relay	Enables or disables BOOTP/DHCP Relay. The Advanced menu defines the preferred servers or the outbound subnetworks for broadcasting a BOOTP/DHCP request.
IGMP Snooping	Enables or disables IGMP Snooping. The Advanced menu sets the timeout for inactive multicast ports or for specific multicast flows when there are no longer any clients.
DVMRP	Enables or disables the Distance-Vector Multicast Routing Protocol.

NOTE: Once RIP and DVMRP have been enabled globally, you can enable or disable them for any specific subnet via the Subnet Configuration menu (

5.7.5.2.1 Setting the ARP Timeout

You can use the following configuration screen to modify the aging time for dynamically learned entries in the ARP cache.

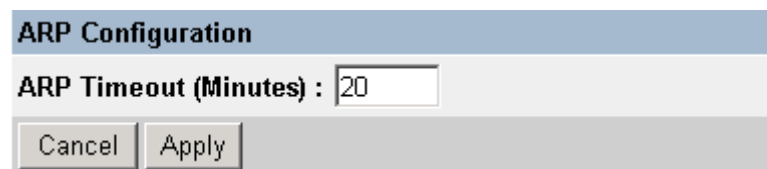

Parameter	Default	Description
ARP Timeout	20 minutes	The time that dynamically learned entries are retained in the ARP cache. Range: 0-999 minutes, where 0 disables aging

5.7.5.2.2 Setting the RIP Advertisement Policy

You can use the following configuration screen to set the timing interval and policies RIP uses to advertise route information.

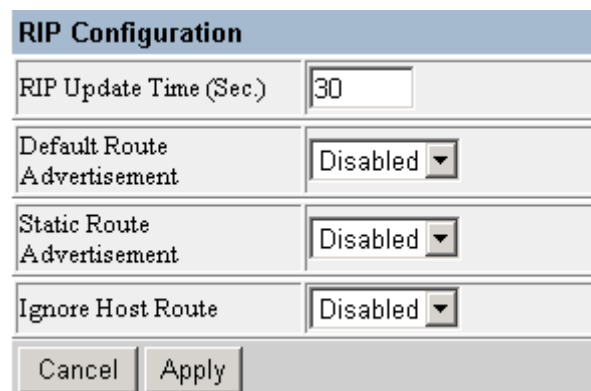

Parameter	Default	Description
RIP Update Time	30 seconds	The interval at which RIP advertises known route information. Range: 0-999 seconds, where 0 disables route advertisements

Default Route Advertisement	Disabled	Enables or disables advertising this switch as a default router.
Static Route Advertisement	Disabled	Enables or disables advertisement of static routes.

5.7.5.2.3 Configuring Global Settings for OSPF

To implement OSPF for a large network, you must first organize the network into logical areas to limit the number of OSPF routers that actively exchange Link State Advertisements (LSAs). You can then define an OSPF interface by assigning an IP interface configured on this switch to one of these groups. This OSPF interface will send and receive OSPF traffic to neighboring OSPF routers. You can further optimize the exchange of OSPF traffic by specifying an area range that covers a large number of subnetwork addresses. This is an important technique for limiting the amount of traffic exchanged between Area Border Routers (ABRs). And finally, you must specify a virtual link to any OSPF area that is not physically attached to the OSPF backbone. Virtual links can also be used to provide a redundant link between contiguous areas to prevent areas from being partitioned, or to merge backbone areas.

The OSPF global configuration consist a configuration page and a few sub-menu.

Parameter	Default	Description
Router ID Selection	STATIC INTF	Defines how the Router ID is determined: There are three options: STATIC: User can manual configure the Router ID. STATIC INTF: The VLAN 1 IP address will be used as Router ID ACTIVE INTF: The first active interface will be used as Router ID
Router ID	VLAN 1 IP	A 32-bit number assigned to each router running the OSPF protocol. This number uniquely identifies the router within an Autonomous System.
RFC 1583 Compatibility	Disabled	Enable or disable the compatibility to RFC 1583 OSPF version 2

Area ID Configuration	Defines an area within which all OSPF routers actively exchange routing information to ensure that they all have an identical link state database.
OSPF Area Range Configuration	Defines a range of subnetwork addresses. An area range is used to summarize route information exchanged between Area Border Routers.
OSPF Virtual Link Configuration	Defines a virtual link that can be used to connect an OSPF area not physically adjacent to the OSPF backbone, or to create a backup link to any area.

5.7.5.2.3.1 OSPF Area Configuration

OSPF protocol broadcast messages (i.e., Link State Advertisements) are restricted by area to limit their impact on network performance. Before assigning an Area ID to a specific OSPF interface, you must first specify the Area ID in this table. Each entry in this table identifies a logical group of OSPF routers that actively exchange Link State Advertisements (LSAs) to ensure that they share an identical view of the network topology. You can configure the area as a normal one which can send and receive external Link State Advertisements (LSAs), a stubby area that cannot send or receive external LSAs, or a not-so-stubby area (NSSA) that can import external route information into its area.

OSPF Area Configuration		
Area ID	Type	Edit
192.168.1.0	NORMAL	
192.168.2.0	NORMAL	
192.168.3.0	NORMAL	
192.168.4.0	NORMAL	
Add New Entry		



Parameter	Description
Area ID	An OSPF area identifier configured for a group of OSPF routers. (For information on how to assign this identifier to a specific interface, see 4.5.6.1.5 Configuring OSPF.)
Type	Indicates area type: Normal – An area which can send or receive external route information. Stub – An area which cannot send or receive external route information. It relies on a single default route provided by its Area Border Router (ABR) to access destinations outside of the stub. A stub can be used to reduce the amount of topology data that has to be exchanged over the network. NSSA – A not so stubby area cannot send but can receive external route information. The ABR imports external routes and floods this information to all routers within the NSSA.

An Autonomous System Boundary Router (ASBR) can import external routes and flood this information to the entire Autonomous System.

5.7.5.2.3.2 OSPF Area Range Configuration

After you configure an area identifier, you can specify a subnetwork address range that covers all the individual networks in this area. This technique limits the amount of traffic exchanged between Area Border Routers (ABRs) by allowing them to advertise a single summary range. By summarizing routes, the routing changes within an area do not have to be updated in the backbone ABRs or in other areas.

To optimize the route summary, first configure all the OSPF routers in an area so that they fall within a contiguous address range. The route summary consists of an address and mask, where the mask can be a Variable Length Subnet Mask (VLSM). Using VLSMs allows you to configure each subnetwork within a larger network with its own subnet mask. This provides a longer subnet mask that covers fewer host IP addresses, thereby reducing the size of the routing tables that have to be exchanged. (For more information on VLSMs, see RFCs 1219 and 1878.)

OSPF Area Range Configuration				
Area Identity	IP Address	Address Mask	Advertisement	Delete
192.168.1.0	192.168.1.0	255.255.255.0	Advertise	
192.168.2.0	192.168.2.0	255.255.255.0	Advertise	
192.168.4.0	192.168.4.0	255.255.255.0	Advertise	
Add New Entry				

Parameter	Description
Area Identity	An OSPF area that includes all the OSPF routers within the assigned address range
IP Address	The IP address used to calculate the area range.
Address Mask	The subnet mask used to calculate the area range.
Advertisement	Enables or disables advertising for this range.

5.7.5.2.3.3 OSPF Virtual Link Configuration

All OSPF areas must connect to the backbone. If an area does not have a direct physical connection to the backbone, you can configure a virtual link that provides a logical path to the backbone. To connect an isolated area to the backbone, the logical path can cross a single nonbackbone area to reach the backbone. To define the path, you must specify one endpoint on the ABR that connects the isolated area to the common nonbackbone area, and the other endpoint on the ABR that connects this common nonbackbone area and the backbone itself. (However, note that you cannot configure a virtual link that runs through a stub or NSSA area.)

Virtual links can also be used to create a redundant link between any area and the backbone to help prevent partitioning, or to connect two existing backbone areas into a common backbone.

To configure a virtual link, specify the transit area through which the endpoint routers connect, and the address of the router on this side of the link.

OSPF Virtual Link Configuration			
Area ID	Neighbor Router ID	Status	Edit
192.168.3.0	192.168.3.254	Down	
Add New Entry			

Parameter	Description
Area ID	An identifier for the transit area the virtual link crosses
Neighbor IP	The IP address of the OSPF router on this end of the virtual link.

Modifying a Virtual Link –

You can modify or delete a virtual link by click edit icon  for the required entry. The screen will display configuration options as shown in the following example.

Modify OSPF Virtual Link Configuration	
Area ID :	192.168.3.0
Neighbor Router IP :	192.168.3.254
Transit Delay (in seconds) :	<input type="text" value="1"/>
Retransmit Interval (in seconds) :	<input type="text" value="5"/>
Hello Interval (in seconds) :	<input type="text" value="10"/>
Dead Interval (in seconds) :	<input type="text" value="40"/>
Authentication Type :	None <input type="button" value="v"/>
Authentication Key :	<input type="text"/> MD5 Table
<input type="button" value="Save"/> <input type="button" value="Delete"/> <input type="button" value="Reset"/> <input type="button" value="Cancel"/>	

Parameter	Default	Description
Area ID		An identifier for the transit area the virtual link crosses.
Neighbor IP		The IP address of the OSPF router on this end of the virtual link.
Transit Delay	1 second	The estimated number of seconds it takes to transmit a link state update packet over this virtual link. Range: 0-3600 seconds
Retransmit Interval	5 seconds	The number of seconds between retransmitting link-state advertisements to the router at the other end on the virtual link. This value is also used when retransmitting database descriptions and link-state request packets. Range: 0-3600 seconds
Hello Interval ²	10 seconds	The interval, in seconds, between sending Hello packets out the router interface. Range: 1-65535 seconds
Dead Interval ²	40 seconds	The number of seconds that a router's Hello packets have not been seen before the router at the other end of the virtual link is declared down. This should be a multiple of the Hello interval. Range: 1-65535 seconds
Authentication Type	None	Authentication can be used to ensure that routing information comes from a valid source. The options include none or a simple password.
Authentication Key		A simple password must be provided if authentication is enabled. (An authentication string is case sensitive, and can be up to 16 characters.)



5.7.5.2.4 Configuring BOOTP/DHCP Relay

If a DHCP/BOOTP server is not located in the same subnet with a host, you can configure this switch to forward any host configuration queries to a server located on another subnet or on another network. Depending on the configuration setup, the switch either:

- Forwards the packet to a preferred server as defined in the switch configuration using unicast routing, or
- Broadcasts the DHCP Request again to another directly attached IP subnet specified in the switch configuration.

Specify the address for any DHCP server, or specify the subnet address for an outbound IP interface already configured on this switch (

5.7.5.1 Subnet Configuration) as described in the following screens.

DHCP Relay Database Configuration	
Index Server Address	Edit
10.1.2.3	
192.168.10.5	

Index Server Address:

Parameter	Description
Index Server Address	Used to define any preferred DHCP servers or the outbound subnetwork for relaying a DHCP request broadcast. (Up to five entries are permitted.)

5.7.5.3 Static ARP Configuration

Use the following screen to display or edit entries in the Static ARP Table. Entries added to this table are retained until the associated IP interface is deleted or the switch is reset to the factory defaults.

Static ARP Table			
IP Address	MAC Address	Interface	Edit
192.168.1.50	12-34-56-12-34-56	1	

IP Address :	<input type="text"/>	MAC Address :	<input type="text"/>	Interface :	<input type="text"/>
<input type="button" value="Add"/>	<input type="button" value="Delete"/>	<input type="button" value="Cancel"/>			

Parameter	Description
IP Address	IP address statically mapped to a physical MAC address.
MAC Address	MAC address statically mapped to the corresponding IP address.
Interface	The index number of the IP interface that will use this static ARP entry. See

5.7.5.1 *Subnet* Configuration or 5.8.6 IP Menu.

5.7.5.4 Static Route Configuration

This switch can be configured to dynamically learn the routes to other IP networks, subnets or hosts using unicast or multicast routing protocols. If the route to a specific destination cannot be learned via these protocols, or you wish to restrict the path used for transmitting traffic to a destination, it can be statically configured using the Static Route Table.

Before defining a static route, remember that you must first configure at least one IP interface on this switch(See

5.7.5.1 *Subnet* Configuration). Static routes take precedence over dynamically learned routes and remain in the table until you remove them or the corresponding IP interface from this switch.

Static Route Table						
Destination Network	Destination mask	Vlan	Next hop	Type	Metrics	Edit
192.168.5.0	255.255.255.0	1	192.168.1.150	Indirect	1	

Destination Network :	<input type="text"/>	Destination Mask :	<input type="text"/>
Next Hop :	<input type="text"/>	Routing Metric :	<input type="text"/>
<input type="button" value="Add"/> <input type="button" value="Delete"/> <input type="button" value="Cancel"/>			

Parameter	Description
Destination Network	A destination network, subnet or host.
Destination Mask	The subnet mask that specifies the bits to match. A routing entry will be used for a packet if the bits in the address set by the destination mask match the Destination Network
VLAN	The VLAN within which the gateway or destination address resides.
Next Hop	The IP address of the router at the next hop. Note that the network portion of the next hop must match that used for one of the subnet IP interfaces configured on this switch. (See “ 5.7.5.1 <i>Subnet</i> Configuration”.)
Type	The IP route type for the destination network. This switch supports the following types: Direct - A directly connected subnetwork. Indirect - A remote IP subnetwork or host address.
Routing Metric*	A relative measure of the path cost from this switch to the destination network.

* This value depends on the specific routing protocol.

5.7.5.5 Configuring the Default Route

Defines the router to which this switch will forward all traffic for unknown networks.

The default route can be learned from RIP protocol or manually configured. If the switch does not contain a default route, any packet that does not match an entry in the routing table will be dropped. To manually configure a default route, enter the next hop in the following table.

Default Route	
VLAN:	0
Next Hop Address:	<input type="text" value="10.1.10.254"/>
Metric:	<input type="text" value="1"/>
<input type="button" value="Apply"/>	<input type="button" value="Delete"/> <input type="button" value="Cancel"/>

Parameter	Description
VLAN	The VLAN which has the IP interface to the default router.
Next Hop Address	The IP address of the default router.
Metric	The number of hops required to reach the default router.

5.7.6 Configuring Security Filters

You can use the Security menu to filter MAC and IP addresses.

Parameter	Description
MAC Filtering Configuration	Specifies the source or destination MAC address for any traffic to be filtered from the switch.
IP Filtering Configuration*	Specifies the source or destination IP address for any traffic to be filtered from the switch.

* This menu item is only displayed for WGS3-404 or multilayer mode of WGS3-2620.

5.7.6.1 Configuring MAC Address Filters

Any node that presents a security risk or is functioning improperly can be filtered from this switch. You can drop all the traffic from a host device based on a specified MAC address. Traffic with either a source or destination address listed in the Security Filtering Configuration table will be filtered.

MAC Filtering Configuration	
MAC Address	Edit
00304F-012345	

MAC Address:	<input type="text"/>	
<input type="button" value="Add"/>	<input type="button" value="Delete"/>	<input type="button" value="Cancel"/>

5.7.6.2 Configuring IP Address Filters

If any node presents a security risk, you can filter all traffic for this node by entering its address into the IP Security Filter. Any packet passing through the switch that has a source or destination IP address matching an entry in this table will be filtered.

IP Filtering Configuration	
IP Filter Entry List	Edit
10.1.1.1	

IP Address :	<input type="text"/>	
<input type="button" value="Add"/>	<input type="button" value="Delete"/>	<input type="button" value="Cancel"/>

5.7.7 Jumbo Packet Configuration

This menu is only available for WGS3-404. In general, Ethernet only allow maximum 1518 bytes packet size. This option allow the switch to transmit up to 9216 bytes packet size to increase data transmission efficiency.

Jumbo Packet Configuration	
Load Default Size :	Yes ▾
Jumbo Packet Length :	1536
<input type="button" value="Apply"/>	<input type="button" value="Cancel"/>

Parameter	Default	Description
Load Default Size	YES	Select YES to use default packet size: 1536. To enable Jumbo Packet function, Toggle it to NO.
Jumbo Packet Size	1536	Specify the maximum packet size allowed on this switch. Range: 1536 to 9216

5.8 Monitoring the Switch

The Network Monitor Menu provides access to port statistics, address tables, STA information, VLANs registration and forwarding information, multicast groups, and subnet addresses. Each of the screens provided by these menus is described in the following sections.

Menu	Description
Port Statistics	Displays statistics on port traffic, including information from the Interfaces Group, Ethernet-like MIB, and RMON MIB.
Layer 2 Address Table	Contains the unicast address table.
Bridge Menu	Displays Spanning Tree settings for the overall switch and for specific ports.
VLAN Menu	Displays ports dynamically learned through GMRP or GVRP, and ports that are currently forwarding VLAN traffic.
IP Multicast Registration Table ¹	Displays all the multicast groups active on this switch, including the multicast IP address and the corresponding VLANs.
IP Menu ²	Displays all the IP subnets used on this switch, as well as the corresponding VLANs and ports. Also contains the ARP table, routing table, and multicast menu.

*1: This menu is only displayed if WGS3-2620 is set to Layer 2 mode.

*2: This menu is only displayed on WGS3-404 or WGS3-2620 when it is set to multilayer mode.

.

5.8.1 Displaying Port Statistics

Port Statistics display standard statistics on network traffic from the Interfaces Group and Ethernet-like MIBs, as well as a detailed breakdown of traffic based on the RMOM MIB.

Parameter	Description
Port Statistics	Displays standard statistics on network traffic passing through the selected port.
RMON Statistics	Displays detailed statistics for the selected port, such as packet type and frame size counters.

5.8.1.1 Displaying Ethernet Port Statistics

Port Statistics display key statistics from the Interfaces Group and Ethernet-like MIBs for each port. Error statistics on the traffic passing through each port are displayed. This information can be used to identify potential problems with the switch, such as a faulty port or unusually heavy loading. The values displayed have accumulated since the last system reboot.

Select the required port. The statistics displayed are indicated in the following figure and table.

Port Number :

Interfaces			
In Octets	19791693	Out Octets	26640496
In Unicast Pkts.	150655	Out Unicast Pkts.	126648
In Non-Unicast Pkts.	20932	Out Non-Unicast Pkts.	3333
In Discards	0	Out Discards	0
In Errors	0	Out Errors	0
Alignment Errors	0	CRC Errors	0

Ethernet			
Single Collisions	0	Multiples Collisions	0
Deferred Transmissions	0	Late Collisions	0
Excess Collisions	0	Carrier Sense Errors	0
Drop Events	0	Fragments	0
Octets	46432189	Jabbers	0

Parameter	Description
Interfaces Group	
In Octets	The total number of octets received on the interface, including framing characters.

In Unicast Pkts.	The number of subnetwork-unicast packets delivered to a higher-layer protocol.
In Non-Unicast Pkts.	The number of non-unicast (that is, subnetwork- broadcast or subnetwork-multicast) packets delivered to a higher-layer protocol.
In Discards	The number of inbound packets which were chosen to be discarded even though no errors had been detected to prevent their being deliverable to a higher-layer protocol. One possible reason for discarding such a packet could be to free up buffer space.
In Errors	The number of inbound packets that contained errors preventing them from being deliverable to a higher-layer protocol.
Alignment Errors	The number of alignment errors (mis-synchronized data packets).
Out Octets	The total number of octets transmitted out of the interface, including framing characters.
Out Unicast Pkts.	The total number of packets that higher-level protocols requested be transmitted to a subnetwork-unicast address, including those that were discarded or not sent.
Out Non-Unicast Pkts.	The total number of packets that higher-level protocols requested be transmitted to a non- unicast (that is, a subnetwork-broadcast or subnetwork-multicast) address, including those that were discarded or not sent.
Out Discards	The number of outbound packets which were chosen to be discarded even though no errors had been detected to prevent their being transmitted. One possible reason for discarding such a packet could be to free up buffer space.
Out Errors	The number of outbound packets that could not be transmitted because of errors.
CRC Errors	Number of Ethernet Cyclic Redundancy Check errors detected by this device.

Ethernet-Like

Single Collisions	The number of successfully transmitted frames for which transmission is inhibited by exactly one collision.
Deferred Transmissions	A count of frames for which the first transmission attempt on a particular interface is delayed because the medium was busy.
Excessive Collisions	The number of frames for which transmission failed due to excessive collisions.
Drop Events	The total number of events in which packets were dropped due to lack of resources.
Octets	Number of octets passing through this port.
Multiple Collisions	A count of successfully transmitted frames for which transmission is inhibited by more than one collision.
Late Collisions	The number of times that a collision is detected later than 512 bit-times into the transmission of a packet.
Carrier Sense Errors	The number of times that the carrier sense condition was lost or never asserted when attempting to transmit a frame.

Fragments	The total number of frames received that were less than 64 octets in length (excluding framing bits, but including FCS octets) and contained either an FCS or alignment error.
Jabbers	The total number of frames received that were longer than 1518 octets (excluding framing bits, but including FCS octets), and contained either an FCS or alignment error.

NOTE: Statistics are refreshed every 10 seconds by default (See 5.3.2 Configuring the Serial Port).

5.8.1.2 Displaying RMON Statistics

Use the RMON Statistics screen to display key statistics for each port from RMON group 1. (RMON groups 2, 3 and 9 can only be accessed using SNMP management software.) The following screen displays the overall statistics on traffic passing through each port. RMON statistics provide access to a broad range of statistics, including a total count of different frame types and sizes passing through each port.

Values displayed have been accumulated since the last system reboot.

Parameter	Description
Drop Events	The total number of events in which packets were dropped due to lack of resources.
Received Bytes	Total number of bytes of data received on the network. This statistic can be used as a reasonable indication of Ethernet utilization.
Received Frames	The total number of frames (bad, broadcast and multicast) received.
Broadcast Frames	The total number of good frames received that were directed to the broadcast address. Note that this does not include multicast packets.
Multicast Frames	The total number of good frames received that were directed to this multicast address.
CRC/Alignment Errors	The number of CRC/alignment errors (FCS or alignment errors).
Undersize Frames	The total number of frames received that were less than 64 octets long(excluding framing bits, but including FCS octets) and were otherwise well formed.
Oversize Frames	The total number of frames received that were longer than 1518 octets(excluding framing bits, but including FCS octets) and were otherwise well formed.
Fragments	The total number of frames received that were less than 64 octets in length(excluding framing bits, but including FCS octets) and contained either an FCS or alignment error.
Jabbers	The total number of frames received that were longer than 1518 octets (excluding framing bits, but including FCS octets), and contained either an FCS or alignment error.
Collisions	The best estimate of the total number of collisions on this Ethernet segment.
64 Byte Frames	The total number of frames (including bad packets) received and transmitted that were 64 octets in length (excluding framing bits but including FCS octets).
65-127 Byte Frames	The total number of frames (including bad packets) received and transmitted where the number of octets fall within the specified range
128-255 Byte Frames	(excluding framing bits but including FCS octets).

256-511 Byte Frames

512-1023 Byte Frames

1024-1518 Byte Frames

1519-1536 Byte Frames

NOTE: Statistics are refreshed every 10 seconds by default (See 5.3.2 Configuring the Serial Port).

5.8.2 Layer 2 Address Tables

This menu includes the unicast address table.

Menu	Description
Unicast Address Table	Provides a full listing for unicast addresses.

5.8.2.1 Displaying the Unicast Address Table

The Unicast Address Table contains the MAC addresses associated with each port (that is, the source port associated with the address). The information displayed in the Address Table is indicated in the following figure and table.

Unicast Address Table	
Address	Port
0000B4-12349A	13
0000B4-5DE98F	13

Parameter	Description
Address	The MAC address of a node seen on this switch.
Port	The port whose address table includes this MAC address.

5.8.3 Displaying Bridge Information

The Bridge menu is used to display settings for the Spanning Tree Algorithm. For a more detailed description of how to use this algorithm, refer to “6.1.3 Spanning Tree Algorithm”.

Menu	Description
Spanning Tree Bridge Information	Displays a full list of STA values used for the bridge.
Spanning Tree Port Information	Displays a list of STA values used for each port, including status, designated cost, designated bridge, and designated port.

5.8.3.1 Viewing the Current Spanning Tree Information

The STA Bridge Information screen displays a summary of STA information for the overall bridge. To make any changes to these parameters, use the Bridge STA Configuration menu as described on 5.7.2 Using the Bridge Menu. The parameters shown in the following figure and table describe the current Bridge STA settings.

STA Bridge Information

Priority : 32768

Hello Time : 2 seconds

Max Age : 20 seconds

Forward Delay : 15 seconds

Hold Time : 1 seconds

Designated Root : 32768.00304F18E640

Root Cost : 0

Root Port : 0

Configuration Changes : 1

Topology Up Time : 672565

Parameter	Description
Priority	Device priority is used in selecting the root device, root port, and designated port. The device with the highest priority becomes the STA root device. However, if all devices have the same priority, the device with the lowest MAC address will then become the root device.
Hello Time	The time interval (in seconds) at which the root device transmits a configuration message.
Max Age	The maximum time (in seconds) a device can wait without receiving a configuration message before attempting to reconfigure.

Forward Delay	The maximum time (in seconds) the root device will wait before changing states (i.e., listening to learning to forwarding).
Hold Time	The minimum interval between the transmission of consecutive Configuration BPDUs.
Designated Root	The priority and MAC address of the device in the Spanning Tree that this switch has accepted as the root device.
Root Cost	The path cost from the root port on this switch to the root device.
Root Port	The number of the port on this switch that is closest to the root. This switch communicates with the root device through this port. If there is no root port, then this switch has been accepted as the root device of the Spanning Tree network.
Configuration Changes	The number of times the Spanning Tree has been reconfigured.
Topology Up Time	The time since the Spanning Tree was last reconfigured.

5.8.3.2 Displaying the Current STA for Ports

The parameters shown in the following figure and table are for port STA Information.

STA Port Information					
Port	Type	Status	Designated Cost	Designated Bridge	Designated Port
1	100BASE-TX	Disabled	0	32768.00304F18E640	128.1
2	100BASE-TX	Disabled	0	32768.00304F18E640	128.2
3	100BASE-TX	Disabled	0	32768.00304F18E640	128.3
4	100BASE-TX	Disabled	0	32768.00304F18E640	128.4
5	100BASE-TX	Disabled	0	32768.00304F18E640	128.5
6	100BASE-TX	Disabled	0	32768.00304F18E640	128.6
7	100BASE-TX	Disabled	0	32768.00304F18E640	128.7
8	100BASE-TX	Disabled	0	32768.00304F18E640	128.8
9	100BASE-TX	Disabled	0	32768.00304F18E640	128.9
10	100BASE-TX	Disabled	0	32768.00304F18E640	128.10

Parameter	Description
Type	Shows port type as: 100BASE-TX : 10BASE-T / 100BASE-TX 1G BASE-T : 1000BASE-T 1000FX: 1000Base-SX/1000Base-LX

Status	<p>Displays current state of this port within the Spanning Tree:</p> <p>Disabled - No link has been established on this port. Otherwise, the port has been disabled by the user or has failed diagnostics.</p> <p>Blocking - Port receives STA configuration messages, but does not forward packets.</p> <p>Listening - Port will leave blocking state due to a topology change, starts transmitting configuration messages, but does not yet forward packets.</p> <p>Learning - Port has transmitted configuration messages for an interval set by the Forward Delay parameter without receiving contradictory information. Port address table is cleared, and the port begins learning addresses.</p> <p>Forwarding - The port forwards packets, and continues the learning addresses.</p> <p>The rules defining port status are:</p> <ul style="list-style-type: none"> ◆ A port on a network segment with no other STA compliant bridging device is always forwarding. ◆ If two ports of a switch are connected to the same segment and there is no other STA device attached to this segment, the port with the smaller ID forwards packets and the other is blocked. ◆ All ports are blocked when the switch is booted, then some of them change state to listening, to learning, and then to forwarding.
Designated Cost	The cost for a packet to travel from this port to the root in the current Spanning Tree configuration. The slower the media, the higher the cost.
Designated Bridge(ID)	The priority and MAC address of the device through which this port must communicate to reach the root of the Spanning Tree.
Designated Port (ID)	The priority and number of the port on the designated bridging device through which this switch must communicate with the root of the Spanning Tree.

5.8.4 Displaying VLAN Information

These menus display information on the ports that have been automatically learned via GVRP and all those ports that have been configured by dynamic or static means to forward VLAN traffic.

Menu	Description
VLAN Dynamic Registration Information	Shows the ports that have been automatically learned via GVRP.
VLAN Forwarding Information	Shows all those ports that have been configured by either dynamic or static means to forward VLAN traffic.

5.8.4.1 VLAN Dynamic Registration Information

This table shows the ports that have been automatically learned via GVRP.

VLAN Dynamic Registration Information	
VLAN	Port Members
1	-
2	-
3	-

5.8.4.2 VLAN Forwarding Information

Shows all those ports that have been configured by either dynamic or static means to forward VLAN traffic.

VLAN Forwarding Information		
VLAN	Type	Port Members
1	Static	1 2 3 4 5 6 7 8 9 10 11 12 13 14 15 16 17 18 19 20 21 22 23 24 25 26
2	Static	1
3	Static	2

5.8.5 IP Multicast Registration Table

This table displays all the multicast groups active on the switch, including the multicast IP address and the corresponding VLANs.

IP Multicast Registration Table			
VLAN	Multicast IP	Multicast Group Ports	Learn By
1	234.7.6.99	26	IGMP

Parameter	Description
VLAN	A VLAN with host members that have asked to receive the indicated multicast service.
Multicast IP	A source IP address that represents a specific multicast service.
Multicast Group Ports	The ports that belong to the indicated VLAN group.
Learned By	Shows if this entry was learned dynamically or via IGMP Snooping. An entry is learned dynamically if a multicast packet was seen crossing the port, or via IGMP Snooping if an IGMP registration packet was seen crossing the port.

5.8.6 IP Menu

This menu contains IP subnets information, the ARP cache, routing table, as well as multicast groups and multicast routing information.

Menu	Description
Subnet Information	Displays all the IP subnets configured on this switch, as well as the corresponding VLANs and ports.
ARP Table	Shows the IP-to-MAC addresses discovered by ARP.
Routing Table	Shows the routes through which all recognized Ethernet networks (and the corresponding VLAN) can be reached.
Multicast Table	Displays all the multicast groups active on this switch, including the multicast IP address and the corresponding VLANs. Also includes the IGMP registration table, the multicast forwarding cache, and DVMRP routing information.
OSPF Table	Displays a link state advertisement summary, the neighbor table, and the virtual neighbor table.

5.8.6.1 Displaying Subnet Information

You can display a list of all the IP interfaces configured on this switch. This table includes the gateway address, corresponding VLAN, and member ports that use this address.

Subnet Information			
IP Address	Subnet Mask	VLAN	Port Members
192.168.1.201	255.255.255.0	1	1 2 3 4 5 6 7 8 9 10 11 12 13 14 15 16 17 18 19 20 21 22 23 24 25 26

Parameter	Description
IP Address	The address for an IP interface on this switch.
Subnet Mask	A template that identifies the address bits in the host address used for routing to specific subnets. Each bit that corresponds to a "1" is part of the network / subnet number; each bit that corresponds to "0" is part of the host number.
VLAN	The VLAN group associated with this IP interface.
Port Members	The ports that can be reached through this IP interface.

5.8.6.2 ARP Table

Address Resolution Protocol (ARP) defines a method for extracting a host's Ethernet address from its Internet address. This table shows the IP-to-MAC address cache discovered via ARP.

ARP Table			
IP Address	Mac Address	VLAN	Port
192.168.1.50	123456-123456	1	0
192.168.1.101	00304F-0B3CB8	1	0
192.168.1.201	00304F-18E640	1	0
203.70.249.51	00304F-0B3E6A	1	0

Parameter	Description
IP Address	IP addresses for which ARP has resolved the physical address through a broadcast message.
MAC Address	MAC address that maps to the corresponding IP address.
VLAN	The VLAN group to which this host has been assigned.
Port	The port this to which host device is attached. (Port "0" refers to an interface defined on this switch.)

5.8.6.3 Routing Table

The Routing Table lists the routes through which all recognized Ethernet networks (and corresponding VLANs) can be reached. This table includes all routes learned through routing protocols or manual configuration.

Routing Table								
Destination Network	Destination Mask	VLAN	Next Hop	Type	Protocol	Route Tag	Route Aging	Routing Metric
192.168.1.0	255.255.255.0	1	192.168.1.201	Direct	Local	-	-	1
192.168.5.0	255.255.255.0	1	192.168.1.150	Indirect	Mgmt	-	-	1

Parameter	Description
Destination Network	A destination network, subnet or host.
Destination Mask	The subnet mask that specifies the bits to match. A routing entry will be used for a packet if the bits in the address set by the destination mask match the Destination Network.

VLAN	The VLAN within which the gateway or destination address resides.
Next Hop	The IP address of the router at the next hop.
Type	The IP route type for the destination network. This switch supports the following types: Direct - A directly connected subnetwork. Indirect - A remote IP subnetwork or host address. Myself - A switch IP address on a specific IP subnetwork. Bcast - A subnetwork broadcast address. Mcast - An IP multicast address. Invalid - A illegal IP address to be filtered.
Protocol	The route was learned in one of the following ways: Local - Manually configured Mgmt. - Set via SNMP ICMP - Obtained via ICMP redirect. RIP - Learned via RIP protocol. OSPF – Learned via OSPF protocol. Other - Learned by some other method.
Route Tag*	The route tag represents the device that originated this routing entry.
Route Aging*	The number of seconds elapsed since this route was last updated or otherwise determined to be correct. (This entry only applies to RIP.)
Routing Metric*	A relative measure of the path cost from this switch to the destination network. (This value depends on the specific routing protocol.)

*These three options is only for WGS3-2620.

5.8.6.4 Multicast Table

You can use this menu to display all the multicast groups currently active on this switch, the IGMP cache, the multicast forwarding cache, and DVMRP routing information.

Parameter	Description
IP Multicast Registration Table	Displays all active multicast groups, including the multicast IP address and the corresponding VLANs. (See 5.8.5 IP Multicast Registration Table.)
IGMP Cache	Displays all active multicast groups, including the IP interface each entry appears on, the entry age, and the time left before the entry is aged out.
Multicast Forwarding Table	Displays all active multicast groups, including the multicast source address, the upstream neighbor, the multicast routing protocol, and the entry age.
DVMRP Routing Table	Displays the source address for each known multicast service, the upstream neighbor, the IP interface each entry appears on, the routing metric, and the entry age.
DVMRP Neighbor Table	Displays all the neighbor routers accessible through each IP interface, including the entry age, the time left before the entry is aged out, the protocol version, and the number of routing updates received from each neighboring router.

5.8.6.4.1 Displaying IGMP Registration Table

The switch provides a local registry of active multicast groups for each IP interface, including the age and expiration time for each entry.

IGMP Registration Table					
Group Address	Interface	Reporter	Up Time	Expire Time	V1 Timer
224.1.1.1	1	192.168.1.19	27000	37500	0

Parameter	Description
Group Address	An IP multicast group address with subscribers directly attached or downstream from this switch.
Interface	The IP interface on this switch that has received traffic directed to the IP multicast group address. (See 5.8.6.1 Displaying Subnet Information.)
Reporter	The IP address of the source of the last membership report received for this IP Multicast group address on this interface. If no membership report has been received, this object has the value 0.0.0.0.
Up Time	The time elapsed since this entry was created.
Expire Time	The time remaining before this entry will be aged out. (The default is 260 seconds.)
V1 Timer	<p>The time remaining until the switch assumes that there are no longer any IGMP Version 1 members on the IP subnet attached to this interface. (The default is 400 seconds.)</p> <p>If the switch receives an IGMP Version 1 Membership Report, it sets a timer to note that there are Version 1 hosts present which are members of the group for which it heard the report.</p> <p>If there are Version 1 hosts present for a particular group, the switch will ignore any Leave Group messages that it receives for that group.</p>

5.8.6.4.2 Displaying the Multicast Forwarding Cache

The switch maintains a cache of multicast routing entries used to calculate the delivery tree in multicast routing protocols. The Multicast Forwarding Cache includes the subnetwork that contains the multicast source and the nearest upstream neighbor for each known multicast group address.

Multicast Forwarding Cache					
Group Address	Source Address	Mask	Upstream Neighbor	Protocol	Up Time
234.7.6.99	10.1.0.0	0.0.0.16	10.1.15.19	DVMRP	15

Parameter	Description
Group Address	An IP multicast group address with subscribers directly attached or downstream from this switch.
Source Address	The IP subnetwork at the root of the multicast delivery tree. This subnetwork contains a known multicast source.
Mask	Subnet mask that is used for the source address. This mask identifies the host address bits used for routing to specific subnets.
Upstream Neighbor	The IP address of the network device immediately upstream for this group.
Protocol	The multicast routing protocol associated with this entry.
Up Time	The time elapsed since this entry was created.

5.8.6.4.3 Displaying the DVMRP Routing Table

The DVMRP Routing Table contains all the IP multicast routes learned by the DVMRP protocol. The routes displayed in this table are used by this switch to forward new IP multicast traffic. They do not reflect active multicast flows.

DVMRP Routing Table					
Source Address	Subnet Mask	Upstream Neighbor	Interface	Metric	Up Time
10.1.0.0	255.255.0.0	0.0.0.0	0	32	1805

Parameter	Description
Source Address	The IP subnetwork at the root of the multicast delivery tree. This subnetwork contains a known multicast source.
Subnet Mask	Subnet mask that is used for the source address. This mask identifies the host address bits used for routing to specific subnets.
Upstream Neighbor	The IP address of the network device immediately upstream for this multicast delivery tree.
Interface	The IP interface on this switch that connects to the upstream neighbor.
Metric	The metric for this interface used to calculate distance vectors.
Up Time	The time elapsed since this entry was created.

5.8.6.4.4 Displaying the DVMRP Neighbor Table

The DVMRP Neighbor Table contains the switch's DVMRP neighbors, as discovered by receiving DVMRP protocol messages.

DVMRP Neighbor Table					
Interface	Neighbor Address	Up Time	Expire Time	Version	Rcv Route
1	10.2.32.254	1237	31	3	21

Parameter	Description
Interface	The IP interface on this switch that connects to the upstream neighbor. (See 5.8.6.1 Displaying Subnet Information.)
Neighbor Address	The IP address of the network device immediately upstream for this multicast delivery tree.
UpTime	The time since this device last became a DVMRP neighbor to this switch.
ExpireTime	The time remaining before this entry will be aged out.
Version	The neighboring router's DVMRP version number.
Rcv Route	The total number of routes received in valid DVMRP packets from this neighbor. This can be used to diagnose problems such as unicast route injection, as well as giving an indication of the level of DVMRP route exchange activity.

5.8.6.5 OSPF Table

You can use this menu to display the OSPF router linkages for the autonomous system based on the Link State Table, Neighbor Table, and Virtual Neighbor Table.

Parameter	Description
Interface Table	Displays interface OSPF status
Link State Table	Displays a summary link state advertisements.
Neighbor Table	Displays current neighbor routers.
Virtual Neighbor	Table Displays current virtual neighbors.

5.8.6.5.1 Display Interface Table

This function allow you to display each IP interface's OSPF status.

OSPF Interface Table					
IP Address	Router ID	Designated Router	Backup DR	Status	Events
192.168.1.254	0.0.0.0	192.168.1.254	0.0.0.0	DR	1

Parameter	Description
IP Address	IP address of the interface
Rtr ID	The OSPF identifier for the neighboring router.
Designated Rtr	The designated router IP address for the broadcast network on the interface
Backup Rtr	The backup designated router IP address for the broadcast network on the interface
Status	The interface status.
Events	The number of events encountered that cause a neighbor state change since boot up.

5.8.6.5.2 Displaying the Link State Table

The link state table displays all advertisements in the link state database. This database contains linkage information for all the areas to which this router is attached. Note that all the routers within an area exchange information to ensure that they maintain an identical link state database. This database can therefore be used to troubleshoot network configuration problems.

OSPF Link State Table

Area ID	Type	Link State ID	Router ID	SN	Age
192.168.1.0	RtrLSA	192.168.1.254	192.168.1.254	0x80000002	1025

Parameter	Description
Area Identity	An OSPF area identifier configured for a group of OSPF routers.
Type	The link state advertisement type: RtrLSA: Router LSA – All area routers advertise the state of links from the router itself to the its local area. NetLSA: Network LSA – The designated router for each area advertises the link state for each transit area; i.e., an area with more than one attached router. This LSA includes information about each router attached to the area, including the designated router itself. SumLSA: Summary LSA – Advertise the cost to a specific subnetwork outside the router's area, or the cost to a specific autonomous system boundary router. ExtLSA: External LSA – Advertises link state information for each known network outside the autonomous system.
Link State ID	The identifier for the router originating this entry, usually in the form of an IP address.
Router ID	The IP address of the originating router.
Sequence No.	The link state sequence number, used to remove previous duplicate LSAs.
Age	The number of seconds since this LSA was originated.

5.8.6.5.3 Displaying the Neighbor Table

Each router exchanges link state information with all neighbors physically attached to the same network segment. This table displays a summary of the link state for all adjacent neighbors. (Note that neighboring routers are discovered by this device via Hello messages.)

OSPF Neighbor Table

IP Address	ID	Router ID	Option	Priority	State	Events
192.168.4.254	0	192.168.4.254	3	1	FULL	6

Parameter	Description
IP Address	IP address of the neighboring router
ID	The index number of the router interface to which this neighbor is attached. For IP protocol, this value will always be zero.
Router ID	The OSPF identifier for the neighboring router.

Option	<p>The optional OSPF capabilities supported by the neighbor. The neighbor's optional OSPF capabilities are also listed in its Hello packets. This enables received Hellos to be rejected (i.e., neighbor relationships will not even start to form) if there is a mismatch in certain crucial OSPF capabilities. The OSPF optional capabilities currently accepted include external routing capability and TOS capability.</p> <p>You need to map the binary bits to the supported options. For example, "3" indicates both routing capability and TOS capability.</p>
Priority	<p>The neighbor's router priority. This priority is used in electing the designated router for the area in which it exists. This value will be set to zero if this router cannot be elected.</p>
State	<p>The communication state for two adjacent routers:</p> <p>Down: This is the initial state of a neighbor conversation. It indicates that there has been no recent information received from the neighbor.</p> <p>Attempt: This state is only valid for neighbors attached to non-broadcast networks. It indicates that no recent information has been received from the neighbor, but that the router is attempting to contact the neighbor by sending Hello packets.</p> <p>Init: A Hello packet has recently been seen from the neighbor. However, bidirectional communication has not yet been established with the neighbor.</p> <p>2-Way: Communication between the two routers has been established. This is the most advanced state short of beginning adjacency establishment. Note that both the Designated Router and Backup Designated Router are selected from the set of neighbors in state 2-Way or greater.</p> <p>ExStart: This is the first step in creating an adjacency between the two neighboring routers. The goal of this step is to decide which router is the master, and to decide upon the initial sequence number. Neighbor conversations in this state or greater are called adjacencies.</p> <p>Exchange: The router is describing its entire link state database by sending database description packets to the neighbor. (Each database description packet has a sequence number, and is explicitly acknowledged.) All adjacencies in Exchange state or greater are used by the flooding procedure. In fact, these adjacencies are fully capable of transmitting and receiving all types of OSPF routing protocol packets.</p> <p>Loading: Link State Request packets are sent to the neighbor asking for more recent advertisements that have been discovered (but not yet received) in the Exchange state.</p> <p>Full: The neighboring routers are fully adjacent. These adjacencies will now appear in router links and network links advertisements.</p>
Events	<p>The number of events encountered that cause a neighbor state change since boot up.</p>

5.8.6.5.4 Displaying the Virtual Neighbor Table

Virtual links can be used to link an area isolated from the backbone, to create a redundant link between any area and the backbone to help prevent partitioning, or to connect two existing backbone areas into a common backbone. Note that the processes of establishing a active link between virtual neighbors is similar to that used for physically adjacent neighbors..

OSPF Virtual Neighbor Table					
Area ID	Router ID	IP Address	Option	State	Events
192.168.9.0	192.168.9.254	192.168.9.254	3	FULL	6

Parameter	Description
Area ID	The transit area the virtual link must cross to connect the border routers.
Router ID	The OSPF identifier for the router at the other end of the link.
IP Address	IP address of the border router at the other end of the link.
Option	<p>The optional OSPF capabilities supported by the neighbor. The neighbor's optional OSPF capabilities are also listed in its Hello packets. This enables received Hellos to be rejected (i.e., neighbor relationships will not even start to form) if there is a mismatch in certain crucial OSPF capabilities. The OSPF optional capabilities currently accepted include external routing capability and TOS capability.</p> <p>You need to map the binary bits to the supported options. For example, "3" indicates both routing capability and TOS capability.</p>

State

The communication state for two adjacent routers:

Down: This is the initial state of a neighbor conversation. It indicates that there has been no recent information received from the neighbor.

Attempt: This state is only valid for neighbors attached to non-broadcast networks. It indicates that no recent information has been received from the neighbor, but that the router is attempting to contact the neighbor by sending Hello packets.

Init: A Hello packet has recently been seen from the neighbor. However, bidirectional communication has not yet been established with the neighbor.

2-Way: Communication between the two routers has been established. This is the most advanced state short of beginning adjacency establishment. Note that both the Designated Router and Backup Designated Router are selected from the set of neighbors in state 2-Way or greater.

ExStart: This is the first step in creating an adjacency between the two neighboring routers. The goal of this step is to decide which router is the master, and to decide upon the initial sequence number. Neighbor conversations in this state or greater are called adjacencies.

Exchange: The router is describing its entire link state database by sending database description packets to the neighbor. (Each database description packet has a sequence number, and is explicitly acknowledged.) All adjacencies in Exchange state or greater are used by the flooding procedure. In fact, these adjacencies are fully capable of transmitting and receiving all types of OSPF routing protocol packets.

Loading: Link State Request packets are sent to the neighbor asking for more recent advertisements that have been discovered (but not yet received) in the Exchange state.

Full: The neighboring routers are fully adjacent. These adjacencies will now appear in router links and network links advertisements.

Events

The number of events encountered that cause a neighbor state change since boot up.

5.9 Resetting the System

Use the Restart command under the Main Menu to reset the management agent. The reset screen is shown below.

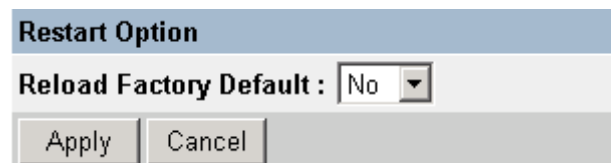

The image shows a dialog box titled "Restart Option". It contains a label "Reload Factory Default :" followed by a dropdown menu currently set to "No". Below the dropdown are two buttons: "Apply" and "Cancel".

Parameter	Description
Reload Factory Defaults	Reloads the factory defaults
[Apply]	Restarts the switch.

NOTE: When restarting the system, it will always run the Power-On Self-Test. It will also retain all system information, unless you elect to reload the factory defaults.

Chapter 6. Advanced Topics

This Layer 3 switch supports both Layer 2 which is based on physical device addresses and Layer 3 switching which is based on IP network addresses. These functions, along with other advanced features are described in this chapter.

6.1 Layer 2 Switching

When a frame enters a port, its destination MAC address is checked in the address database to see which port leads to this destination. If the destination address belongs to the incoming port, the frame is dropped or “filtered.” If the destination port is found on another port, the frame is forwarded to that port and queued for output. But, if the destination address is **not** found in the address database, the frame is sent to one or more output ports based on the rules for handling tagged or untagged VLAN frames.

If the source MAC address of the frame was not found in the address database, it is recorded along with the incoming port number where it entered the switch. This information is then used to make later decisions for frame forwarding.

During switching, the switch performs multiple steps, including:

- VLAN Classification
- Learning
- Filtering
- Forwarding
- Aging

The following sections provide additional information about the tasks the switch performs during unicast and multicast switching.

6.1.1 Unicast Switching

This section describes VLAN classification, learning, filtering, and forwarding for unicast switching.

- **VLAN Classification**— When the switch receives a frame, it classifies the frame in one of two ways:
 - If the frame is untagged, the switch classifies the frame into the default VLAN for the incoming port.
 - If the frame is tagged, the switch uses the tagged VLAN ID to identify the broadcast domain of the frame.

- **Learning** — After VLAN classification, the switch checks the <source MAC address, VLAN> pair in the address table to see whether this pair is known.
 - If unknown, the switch adds this pair to the address table.
 - If known, the switch checks the pair for an incorrect Port ID. If the PID associated with the pair in the address table is different from the receiving port, the switch modifies the PID in the address table.

- **Filtering**— After learning the address, the switch checks:
 - If the source or destination port is not in the forwarding state. (For example, if it is in blocking state or has been disabled.)
 - If the source or destination MAC address is to be filtered.
 - If the source PID is the same as the destination PID.

If any of these conditions are met, the switch drops the received frame. Otherwise, it continues with the forwarding process as described below.

- **Forwarding**— During the forwarding process, the switch checks whether the <destination MAC address, VLAN> pair is unknown.
 - If unknown, the switch floods the received frame to all ports in the VLAN, excluding the source port.
 - If known, the switch forwards the received frame to the port associated with the pair. At the same time, the switch decides whether a VLAN tag needs to be added to or stripped from the frame, depending on the VLAN tagged/untagged configuration and VLAN ID for the output port.

- **Aging**— the switch performs the aging process for the <MAC addresses, VLAN> pair in the MAC address table. Once a pair is aged out, the address table is modified.

6.1.2 Multicast Switching

For multicast switching, the switch checks whether the received frame is a Bridge Protocol Data Unit (BPDU). If a BPDU is received, the switch forwards the frame for processing by the Spanning Tree Protocol. Otherwise, the switch performs the following processes:

- VLAN classification— same as for unicast switching.
- Learning— same as for unicast switching.
- Filtering— after learning, the switch checks the same filtering criteria used for unicast switching, except that there is no destination MAC address to check.
- Forwarding— the switch floods the received multicast frame to all ports within the VLAN, excluding the source port. At the same time, the switch decides whether a VLAN tag needs to be added to or stripped from the frame, depending on the VLAN tagged/untagged configuration and VLAN ID for the output port.
- Aging— same as for unicast switching.

6.1.3 Spanning Tree Algorithm

The Spanning Tree Algorithm (that is, the STA-configuration algorithm as outlined in IEEE 802.1D) can be used to detect and disable network loops, and to provide link backup. This allows the switch to interact with other bridging devices (including STA-compliant switches, bridges or routers) in your network to ensure that only one route exists between any two stations on the network. If redundant paths or loops are detected, one or more ports are put into a blocking state (stopped from forwarding packets) to eliminate the extra paths. Moreover, if one or more of the paths in a stable spanning tree topology fail, this algorithm will automatically change ports from blocking state to forwarding state to reestablish contact with all network stations.

STA uses a distributed algorithm to select a bridging device (STA-compliant switch, bridge or router) that serves as the root of the spanning tree network. It selects a root port on each bridging device (except for the root device) which incurs the lowest path cost when forwarding a packet from that device to the root device. Then it selects a designated bridging device from each LAN which incurs the lowest path cost when forwarding a packet from that LAN to the root device. All ports connected to designated bridging devices are assigned as designated ports.

After determining the lowest cost spanning tree, it enables all root ports and designated ports, and disables all other ports. Network packets are therefore only forwarded between root ports and designated ports, eliminating any possible network loops.

Once a stable network topology has been established, all bridges listen for Hello BPDUs (Bridge Protocol Data Units) transmitted from the Root Bridge. If a bridge does not get a Hello BPDU after a predefined interval (Maximum Age), the bridge assumes that the link to the Root Bridge is down. This bridge will then initiate negotiations with other bridges to reconfigure the network to reestablish a valid network topology.

The following figure gives an illustration of how the Spanning Tree Algorithm assigns bridging device ports.

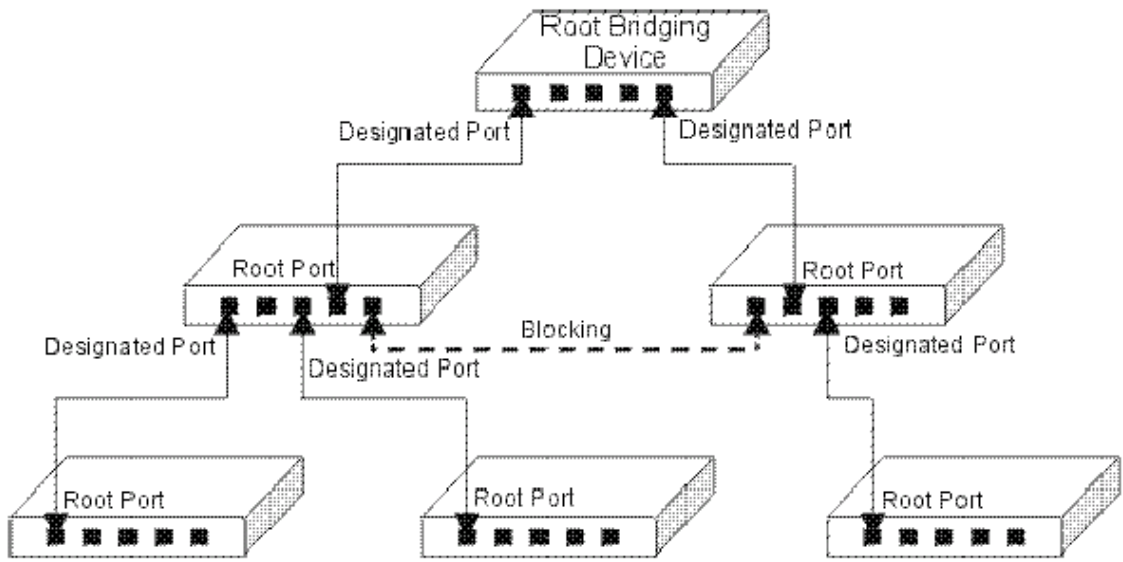

6.2 Layer 3 Switching

The two major functions provided by a Layer 3 switch include IP Switching and Routing Path Management. When the switch is set to multilayer mode, it acts as a routing switch, with support for standard IP routing and the ability to pass traffic between VLANs as required. However, when the switch is first set to multilayer mode, no default routing is defined. As with all traditional routers, the routing function must first be configured to work. (RIP).

6.2.1 Initial Configuration

In the default configuration, all ports belong to the same virtual LAN and the switch provides only Layer 2 functionality. So you should first group all the ports that belong to the same subnet into virtual LANs. By separating the switch into different VLANs, the network is partitioned into subnetworks that are disconnected at Layer 2. Network traffic within the same subnet is still switched using Layer 2 switching. And the VLANs can now be interconnected (only as required) with Layer 3 switching. Each VLAN represents a virtual interface to Layer 3. You just need to provide the network addresses for each virtual interface, and the traffic between different subnetworks will be routed by Layer 3 switching.

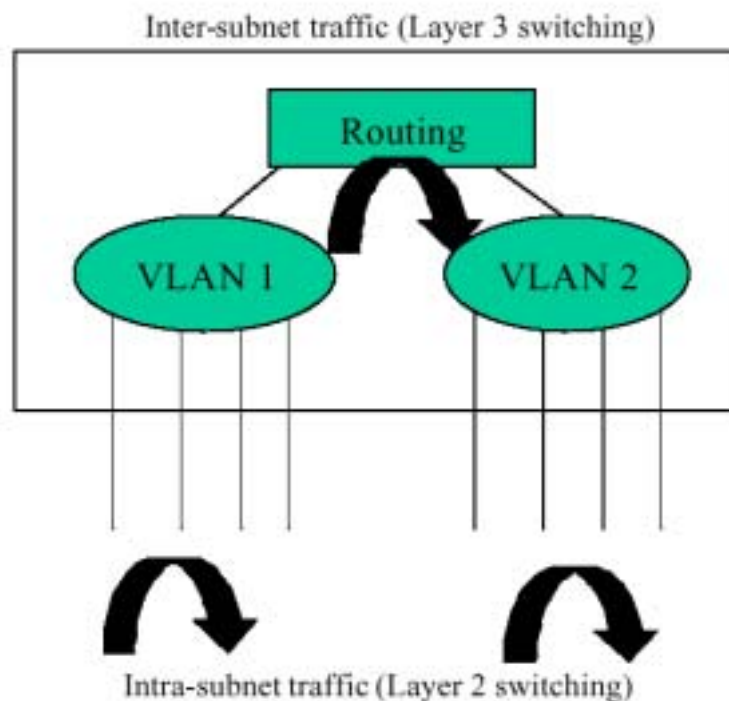

VLAN Configuration for Layer 3

Note: When operating the switch in multilayer mode, all ports should be defined as untagged, and no VLANs can overlap. You should also assign the same default PVID to the ports at both ends of a link if the VLAN must cross the switches. (See "VLAN Tagging" configuration.) These limitations will be removed for future firmware versions.

6.2.2 IP Switching

IP Switching (or packet forwarding) encompasses tasks required to forward packets for both Layer 2 and Layer 3, as well as traditional routing.

These functions include:

- Layer 2 forwarding (switching) based on the Layer 2 destination MAC address
- Layer 3 forwarding (routing):
 - Based on the Layer 3 destination address
 - Replacing destination/source MAC addresses for each hop
 - Incrementing the hop count
 - Decrementing the time-to-live
 - Verifying and recalculating the Layer 3 checksum

If the destination node is on the same subnetwork as the source network, then the packet can be transmitted directly without the help of a router.

However, if the MAC address is not yet known to the switch, an Address Resolution Protocol (ARP) packet with the destination IP address is broadcast to get the destination MAC address from the destination node. The IP packet can then be sent directly with the destination MAC address.

If the destination belongs to a different subnet on this switch, the packet can be routed directly to the destination node. However, if the packet belongs to a subnet not included on this switch, then the packet should be sent to a router (with the MAC address of the router used as the destination MAC address, and the destination IP address of the destination node). The router will then forward the packet to the destination node via the correct path. The router can also use the ARP protocol to find out the MAC address of the destination node of the next router when necessary.

Note: In order to perform IP switching, the switch should be recognized by other network nodes as an IP router, either by setting it as the default gateway, or by redirection from another router via the ICMP process.

When the switch receives an IP packet addressed to its own MAC address, the packet follows the Layer 3 routing process. The destination IP address is checked against the Layer 3 address table. If the address is not already there, the switch broadcasts an ARP packet to all the ports on the destination VLAN to find out the destination MAC address. After the MAC address is discovered, the packet is reformatted and sent out to the destination. The reformat process includes decreasing the Time-To-Live (TTL) field of the IP header, recalculating the IP header checksum, and replacing the destination MAC address with either the MAC address of the destination node or that of the next hop router.

When another packet destined to the same node arrives, the destination MAC can be retrieved directly from the Layer 3 address table; the packet is then reformatted and sent out the destination port. IP switching can be done at wire-speed when the destination address entry is already in the Layer 3 address table.

If the switch determines that a frame must be routed, the route is calculated only during setup. Once the route has been determined, all packets in the current flow are simply switched or forwarded across the chosen path. This takes advantage of the high throughput and low latency of switching by enabling the traffic to bypass the routing engine once path calculation has been performed.

6.2.3 Routing Path Management

Routing Path Management involves the determination and updating of all the routing information required for packet forwarding, including:

- Handling routing protocols
- Updating the routing table
- Updating the Layer 3 switching database

6.2.4 ICMP Router Discovery

Before a host can send IP datagrams beyond its directly attached subnet, it must discover the address of at least one operational router on that subnet.

Typically, this can be accomplished by reading a list of one or more router addresses from a configuration file at start-up time. On multicast links, some hosts also discover router addresses by listening to routing protocol traffic.

The ICMP Router Discovery message is an alternative router discovery method that uses a pair of ICMP messages on multicast links. It eliminates the need to manually configure router addresses and is independent of any specific routing protocol.

ICMP Router Discovery messages are called "Router Advertisements" and "Router Solicitations." Each router periodically multicasts a Router Advertisement from each of its multicast interfaces, announcing the IP address(es) of that interface. Hosts discover the addresses of their neighboring routers simply by listening for advertisements. When a host attached to a multicast link starts up, it may multicast a Router Solicitation to ask for immediate advertisements, rather than waiting for the subsequent, periodic ones to arrive.

Router Discovery messages do not constitute a routing protocol: they enable hosts to discover the existence of neighboring routers, but not which router provides a route to a particular destination. If a host chooses a poor first-hop router for a particular destination, it should receive an ICMP Redirect from that router, identifying a better one.

6.2.5 Proxy ARP

When a node in the attached subnetwork does not have routing or a default gateway configured, ARP Proxy can be used to forward an ARP request to a remote subnetwork. When the switch receives an ARP request for a remote network and ARP Proxy is enabled, it determines if it has the best route to the remote network, and then answers the ARP request by sending its own MAC address to the requesting node. That node then sends traffic to the switch, which in turn uses its own routing table to forward the traffic to the remote destination. End stations that require Proxy ARP must view the entire network as a

single network. These nodes must therefore use a smaller subnet mask than that used by the switch or other relevant network devices.

Note that extensive use of Proxy ARP can adversely affect the performance of the switch because it may lead to increased ARP traffic and increased search time for larger ARP address tables.

6.2.6 Routing Protocols

The switch supports both static and dynamic routing.

- Static routing requires routing information to be stored in the switch, either manually or when a connection is set up by an application outside the switch.
- Dynamic routing uses a routing protocol to exchange routing information, calculate routing tables, and respond to changes in the status or loading of the network.

Dynamic routing involves the determination and updating of all the routing information required for packet forwarding.

- Handling routing protocols
- Updating the routing table
- Updating the Layer 3 switching database

The switch supports RIP and RIP-2 dynamic routing protocols.

6.2.6.1 RIP and RIP-2 Dynamic Routing Protocols

The RIP protocol is the most widely used routing protocol. The RIP protocol uses a distance vector-based approach to routing. Routes are determined on the basis of minimizing the distance vector, or hop count, which serves as a rough estimate of transmission cost. Each router broadcasts its advertisement every 30 seconds, together with any updates to its routing table. This allows all routers on the network to learn consistent tables of next hop links which lead to relevant subnets. Just as Layer 2 switches use the Spanning Tree Algorithm to prevent loops, routers also use methods for preventing loops that would cause endless retransmission of data traffic. RIP utilizes the following three methods to prevent loops from occurring:

- Split horizon— never propagate routes back to an interface port from which they have been acquired.
- Poison reverse— propagate routes back to an interface port from which they have been acquired, but set the distance vector metrics to infinity. (This provides faster convergence.)
- Triggered updates— whenever a route gets changed, broadcast an update message after waiting for a short random delay, but without waiting for the periodic cycle.

RIP-2 is a compatible upgrade to RIP. RIP-2 adds useful capabilities for plain text authentication, multiple independent RIP domains, variable length subnet masks, and multicast transmissions for route advertising (RFC 1388).

There are several serious problems with RIP that you should consider before deciding which routing protocol to use for your network. First of all, RIP (version 1) has no knowledge of subnets, both RIP versions can take a long time to converge on a new route after the failure of a link or router during which time routing loops may occur, and its small hop count limitation of 15 restricts its use to smaller networks.

Moreover, RIP (version 1) wastes valuable network bandwidth by propagating routing information via broadcasts, nor does it consider enough network variables to make the best routing decision.

4-8

6.2.6.2 OSPFv2 Dynamic Routing Protocol

OSPF overcomes all the problems of RIP. It uses a link state routing protocol to generate a shortest-path tree, then builds up its routing table based on this tree. OSPF produces a more stable network because the participating routers act on network changes predictably and simultaneously, converging on the best route more quickly than RIP. Moreover, when several equal-cost routes to a destination exist, traffic can be distributed equally among them.

OSPF looks at more than just the simple hop count. When adding the shortest path to any node into the tree, the optimal path is chosen on the basis of delay, throughput and connectivity. OSPF utilizes IP multicast to reduce the amount of routing traffic required when sending or receiving routing path updates. The separate routing area scheme used by OSPF further reduces the amount of routing traffic, and thus inherently provides another level of routing protection. In addition, all routing protocol exchanges can be authenticated. Finally, the OSPF algorithms have been tailored for efficient operation in TCP/IP Internets.

OSPFv2 is a compatible upgrade to OSPF. It involves enhancements to protocol message authentication, and the addition of a point-to-multipoint interface which allows OSPF to run over non-broadcast networks, as well as support for overlapping area ranges.

Area Configuration – OSPF routers exchange information with other routers in their area to determine the shortest path to every destination. Each router in a common area should therefore have an identical map of their local network topology. At the top level, the largest area is known as an Autonomous System, and contains all the routers in your network. However, for large networks you should organize your OSPF routers into smaller contiguous areas to reduce the amount of routing information that has to be exchanged and to simplify network management.

When designing an OSPF network architecture, first create a backbone area to which all other areas are adjacent. Note that when you enable OSPF for any IP interface on the ES3627, it is assigned to the backbone by default (Area 0.0.0.0).

As a general rule, no area should not contain more than 50 routers. To create a new area, designate an Area ID that will be used by all of the other routers in this area, specify the area type as Normal, Stub, or NSSA (page 2-59 or 3-44), and then assign the ID to an interface (page 2-52 or 3-39). A Stub does not accept or send external routing information. Instead, it uses a single default route for destinations outside the area. Stubs further minimize the amount of routing data that has to be stored or exchanged with other areas. An NSSA (Not-So-Stubby Area) is similar to a Stub, except that it can import external route information into its area. Note that if there are not external routes into your network, then there are no advantages to configuring a Stub or NSSA.

Neighbors – Neighboring OSPF routers within a common area are found using Hello messages. These messages also list the other routers from which the originator has received hello messages. When a router finds its address in the hello messages received from another router, both routers initiate communications as neighbors.

Only after these routers successfully exchange and synchronize their routing tables, will they be considered fully adjacent (page 2-98 or 3-69). Routing information is only exchanged between adjacent neighbors.

Designated Router – A Designated Router (DR) and Backup Designated Router (BDR) are selected by

the OSPF protocol for each area. The Designated Router exchanges routing information with all other routers in its area, and then floods Link State Advertisements (LSAs) to each router, allowing them to update their database. This eliminates the need for each router to exchange information with every other router in its area. The OSPF protocol selects the DR and BDR based on the router with the highest priority, or highest Router ID in case of a tie.

Area Border Router – An Area Border Router (ABR) must be configured between each area and the backbone. An ABR should be configured with an IP interface that connects directly to both the backbone and the area on which it borders. However, if an area is not physically connected to the backbone, you can configure a virtual link that crosses a neighboring area to reach the backbone. Just define an ABR (i.e., virtual neighbor) on the boundary between the isolated area and transit area, as well as an ABR on the boundary between the transit area and the backbone. An ABR can be situated between one or more areas, but we advise limiting the maximum number of areas supported by a single ABR to three. You can also define a virtual link as a backup path between an ABR and the backbone.

Area Range – An ABR maintains a separate routing table for each area to which it is attached, and sends routing summaries for each attached area to the backbone, which in turn distributes this information to other areas in the autonomous system. This reduces the size of the routing tables that have to be maintained throughout the system, and prevents frequent updates from flooding the system whenever a link change occurs. To configure a routing summary, you must define the OSPF Area Range for all the networks within an ABR's area. This range is specified with an IP address and network mask (page 2-60 or 3-45). Moreover, since OSPF supports Variable Length Subnet Masks (VLSMs), you can specify a mask on a bit boundary, which can further reduce the number of advertised addresses.

Autonomous System Boundary Router – An Autonomous System (AS) contains all the routers in your network, each of which shares information with other routers to determine a shortest-path route to every destination in the AS. However, when an AS is connected to an outside network, it must import external routing information through an Autonomous System Boundary Router (ASBR). An ASBR can import routing information through other routing protocols such as RIP.

An ASBR will generate external link advertisements on selected interfaces if OSPF is enabled globally, and any of the following conditions exist on an interface:

- RIP is enabled, or
- RIP and OSPF are both disabled.

Link State Advertisements – Each router maintains a link state database that contains information received from all the other routers within the same area. There are four types of Link State Advertisements (LSA). Router LSAs advertise area links known by the originator, and are issued by all routers. Network LSAs advertise transit areas through which traffic can be passed to reach other areas in the system. Network LSAs contain information about all the routers that provide a link across the transit area, and are issued by Designated Routers.

Summary LSAs are issued by Area Border Routers (ABR), and advertise routing information for a single subnetwork outside the ABR's area or for an Autonomous System Boundary Router (ASBR). External LSAs are issued by the ASBR, and contain information about external networks outside the AS.

Virtual Links – All areas within an Autonomous System must connect to the backbone. In cases where an area cannot be physically connected to the backbone, you can create a virtual link which crosses a transit area to reach the backbone.

(Virtual links can only span one intermediate area to reach the backbone.) Virtual links can be used as a redundant link, preventing partitioning from the backbone. They can also be used to merge two separate backbone areas.

To create a virtual link, you must specify an Area Border Router (ABR) and a common transit area at both ends of the link (page 2-61 or 3-46). One ABR will border on the target area and the transit area, while the other borders on the transit area and the backbone. The configuration on each router must include the transit area identifier and the ABR at the other end of the link.

6.2.7 Non-IP Protocol Routing

The switch supports IP routing only. Non-IP protocols such as IPX and AppleTalk can not be routed by this switch, and will be confined within their local VLAN group unless bridged by an external router.

To coexist with a network built on other multilayer switches, the subnetworks for non-IP protocols must follow the same logical boundary as that of the IP subnetworks. A separate multi-protocol router can then be used to link the subnetworks by connecting to one port from each available VLAN on the network.

6.3 Virtual LANs

Switches do not inherently support broadcast domains, which can lead to broadcast storms in large networks that handle a lot of traffic such as NetBUEI or IPX. In conventional networks with routers, broadcast traffic is split up into separate domains to confine this traffic to the originating group and provide a much cleaner network environment. Instead of using physically separate subnets which are linked by traditionally slow routers, this switch creates segregated broadcast domains based on easily configurable VLANs, and then links these VLANs as required with wire-speed routing.

An IEEE 802.1Q VLAN is a group of ports that can be located anywhere in the network, but communicate as though they belong to the same physical segment. VLANs help to simplify network management by allowing you to move devices to a new VLAN without having to change any physical connections. VLANs can be easily organized to reflect departmental groups (such as Marketing or R&D), usage groups (such as e-mail), or multicast groups (used for multimedia applications such as video conferencing).

VLANs provide greater network efficiency by reducing broadcast traffic, and allow you to make network changes without having to update IP addresses or IP subnets. VLANs inherently provide a high level of network security since traffic must pass through a configured Layer 3 link to reach a different VLAN.

This switch supports the following VLAN features:

- Up to 255 VLANs based on the IEEE 802.1Q standard
- Distributed VLAN learning across multiple switches using explicit or implicit tagging and GVRP protocol
- Port overlapping, allowing a port to participate in multiple VLANs (Not supported for multilayer mode.)
- End stations can belong to multiple VLANs
- Passing traffic between VLAN-aware and VLAN-unaware devices
- Priority tagging

6.3.1 Assigning Ports to VLANs

Before enabling VLANs for the switch, you must first assign each port to the VLAN group(s) it will participate in. By default all ports are assigned to VLAN 1 as untagged ports. Add a port as a tagged port (that is, a port attached to a VLAN-aware device) if you want it to carry traffic for one or more VLANs and the device at the other end of the link also supports VLANs. Then assign the port at the other end of the link to the same VLAN(s). However, if you want a port on this switch to participate in one or more VLANs, but the device at the other end of the link does not support VLANs, then you must add this port as an untagged port (that is, a port attached to a VLAN-unaware device).

6.3.1.1 VLAN Classification

When the switch receives a frame, it classifies the frame in one of two ways. If the frame is untagged, the switch assigns the frame to an associated VLAN (based on the PVID of the receiving port). But if the frame is tagged, the switch uses the tagged VLAN ID to identify the port broadcast domain of the frame.

6.3.1.2 Port Overlapping

Port overlapping can be used to allow access to commonly shared network resources among different VLAN groups, such as file servers or printers. (Not supported for multilayer mode of WGS3-2620) Note that if you implement VLANs which do not overlap, but still need to communicate, you can connect them by setting this switch to multilayer mode, and assigning an IP interface address to the different VLANs. (See "Connecting VLAN Groups")

6.3.1.3 Port-based VLANs

Port-based (or static) VLANs are manually tied to specific ports. The switch's forwarding decision is based on the destination MAC address and its associated port. Therefore, to make valid forwarding or flooding decisions, the switch must learn the relationship of the MAC address to its related port—and thus to the VLAN—at run-time. However, when GVRP is enabled, this process can be fully automated.

6.3.1.4 Automatic VLAN Registration (GVRP)

GVRP defines a system whereby the switch can automatically learn the VLANs each endstation should be assigned to. If an endstation (or its network adapter) supports the IEEE 802.1Q VLAN protocol, it can be configured to broadcast a message to your network indicating the VLAN groups it wants to join. When this switch receives these messages, it will automatically place the receiving port in the specified VLANs, and then forward the message to all other ports. When the message arrives at another switch that supports GVRP, it will also place the receiving port in the specified VLANs, and pass the message on to all other ports. VLAN requirements are propagated in this way throughout the network. This allows GVRP-compliant devices to be automatically configured for VLAN groups based solely on endstation requests.

6.3.2 Forwarding Tagged/Untagged Frames

Ports can be assigned to multiple tagged or untagged VLANs. Each port on the switch is therefore capable of passing tagged or untagged frames.

To forward a frame from a VLAN-aware device to a VLAN-unaware device, the switch first decides where to forward the frame, and then strips off the VLAN tag. However, to forward a frame from a VLAN-unaware device to a VLAN-aware device, the switch first decides where to forward the frame, and then inserts a VLAN tag reflecting this port's default VID.

The default PVID is VLAN 1 for all ports, but this can be changed.

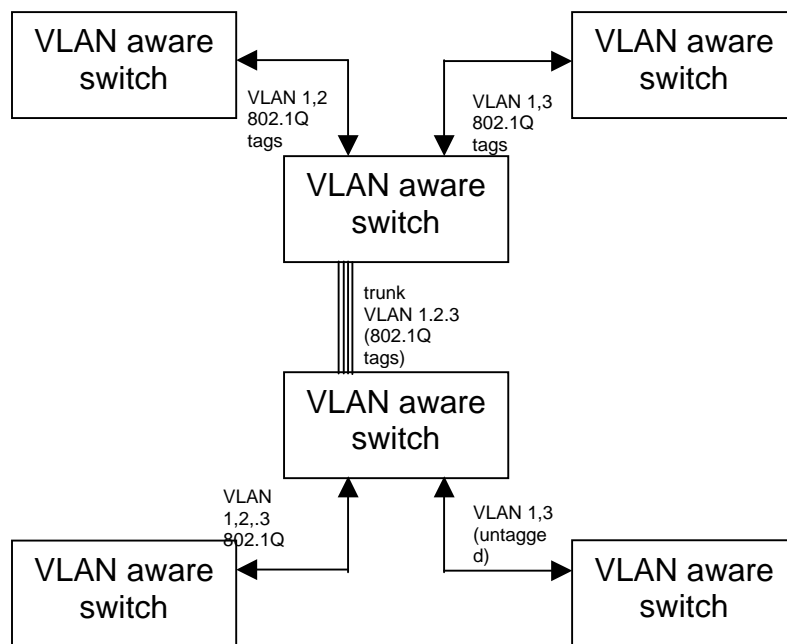

6.3.3 Connecting VLAN Groups

The switch supports communication within a common VLAN using store-and-forward switching. However, if you have devices in separate VLANs that must communicate, and it is not practical to include these devices in a common VLAN, then the VLANs can be connected via Layer 3 routing provided by this switch.

Traditional routers use only physical port numbers in their routing tables, which provides no support for VLANs. By contrast, this device supports Layer 3 routing by using both logical and physical port numbers to support VLANs and Layer 3 switching simultaneously.

By using the abstraction of a logical port number to represent a collection of physical switch ports in the same VLAN, Layer 3 switching can occur from one VLAN to another transparently without changing the routing protocol and IP routing software, while Layer 2 switching is still used for intra-VLAN traffic.

The switch uses standard routing tables that are constructed via static configuration or dynamic routing protocols such as RIP. Each routing entry consists of a network address (that is, an IP address with a subnet mask), and a virtual interface number. Each virtual interface corresponds to a virtual LAN, identified by the VLAN ID. Also note that multiple routing entries can be provided for the same virtual interface by adding the required routing table entries for the same virtual interface. A simple VLAN configuration that supports routing is shown below.

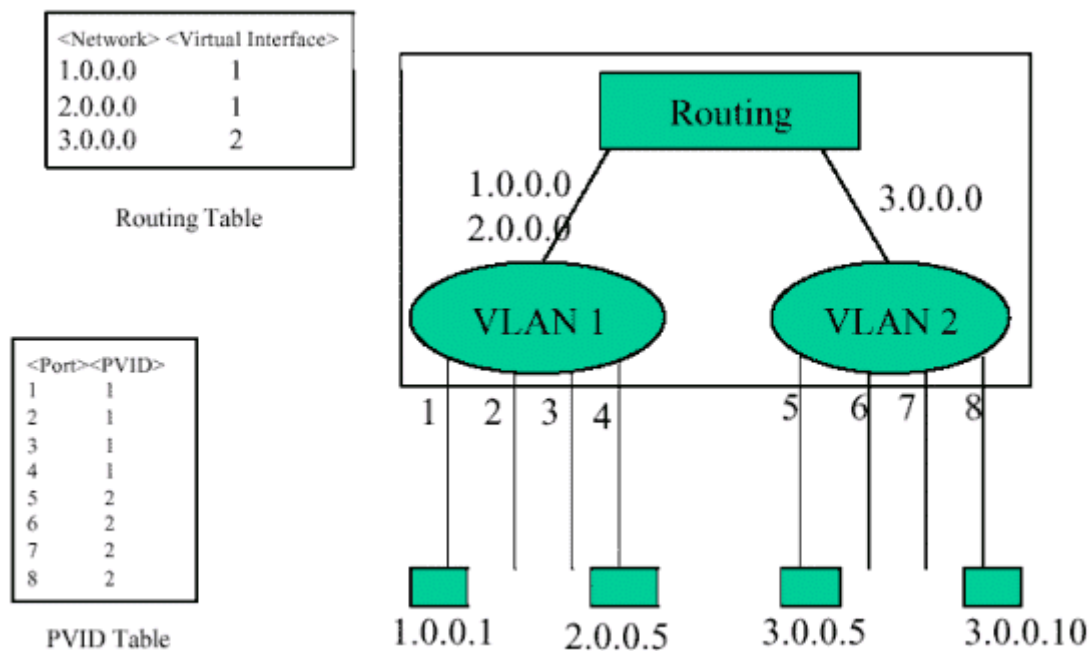

VLANs Connected via IP Routing

6.4 Multicast Filtering

Multicasting sends data to a group of nodes instead of a single destination. The simplest way to implement multicasting is to broadcast data to all nodes on the network. However, such an approach wastes a lot of bandwidth if the target group is small compared to the overall broadcast domain.

Since applications such as video conferencing and data sharing are widely used today, efficient multicasting has become vital. A common approach is to use a group registration protocol that lets nodes join or leave multicast groups. A switch or router can then easily determine which ports contain group members and send data out to those ports only. This procedure is called multicast filtering.

The purpose of IP multicast filtering is to optimize a switched network's performance, so multicast packets will only be forwarded to those ports containing multicast group hosts or multicast routers/switches, instead of flooding traffic to all ports in the subnet (VLAN).

The switch routing switch supports IP multicast filtering not only by passively monitoring IGMP Query and Report messages and DVMRP Probe messages to register end-stations as multicast group members (Layer 2), but also by actively sending GMRP Query messages to learn the location of multicast routers/switches and member hosts in multicast groups within each VLAN (Layer 3). This switch also supports the DVMRP multicast routing protocol required to forward multicast traffic to other subnets.

6.4.1 IGMP Snooping

A Layer 2 switch can passively snoop on IGMP Query and Report packets transferred between IP multicast routers/switches and IP multicast host groups to learn the IP multicast group members. It simply monitors the IGMP packets passing through it, picks out the group registration information, and configures multicast filters accordingly. IGMP Snooping generates no additional network traffic, allowing you to significantly reduce the multicast traffic passing through your switch.

6.4.2 IGMP Protocol

The Internet Group Management Protocol (IGMP) runs between hosts and their immediately neighboring multicast router/switch. IGMP is as a multicast host registration protocol that allows any host to inform its local router that it wants to receive transmissions addressed to a specific multicast group.

A router, or multicast-enabled switch, can periodically ask their hosts if they want to receive multicast traffic. If there is more than one router/ switch on the LAN performing IP multicasting, one of these devices is elected "querier" and assumes the responsibility of querying the LAN for group members. It then propagates the service requests on to any neighboring multicast switch/router to ensure that it will continue to receive the multicast service.

Based on the group membership information learned from IGMP, a router/switch can determine which (if any) multicast traffic needs to be forwarded to each of its ports. At Layer 3, multicast routers use this information, along with a multicast routing protocol such as DVMRP, to support IP multicasting across the Internet.

Note that IGMP neither alters nor routes any IP multicast packets. A multicast routing protocol must be used to deliver IP multicast packets across different subnetworks. Therefore, when DVMRP routing is enabled for a subnet on this switch, the switch will automatically enable IGMP.

6.4.3 GMRP Protocol

GARP Multicast Registration Protocol (GMRP) allows network devices to register end-stations with multicast groups. GMRP requires that any participating network devices or end-stations comply with the IEEE 802.1p standard. Compliant end-stations can request to receive traffic from a multicast group simply by issuing a *join* packet that includes a known multicast address. When the join packet reaches a port on the switch, it configures this port to receive multicast traffic for the requested group, and then issues a similar join packet to all other ports on the switch, informing them that incoming multicast traffic for the stated group is to be forwarded to the requesting port.

6.4.4 DVMRP Routing Protocol

The Distance-Vector Multicast Routing Protocol (DVMRP) behaves somewhat similar to RIP. A router supporting DVMRP periodically floods its attached networks to pass information about supported multicast services along to new routers and hosts. Routers that receive a DVMRP packet send a copy out to all paths (except the path back to the origin). These routers then send a prune message back to the source to stop a data stream if the router is attached to a LAN that does not want to receive traffic from a particular multicast group. However, if a host attached to this routing switch issues an IGMP message indicating that it wants to subscribe to the concerned multicast service, this switch will use DVMRP to build up a source-rooted multicast delivery tree that allows it to prevent looping and determine the shortest path to the source of this multicast traffic.

When this switch receives the multicast message, it checks its unicast routing table to locate the port that provides the shortest path back to the source. If that path passes through the same port the multicast message was received on, then this switch records path information for the concerned multicast group in its routing table and forwards the multicast message on to adjacent routers, except for the port through which the message arrived on. This process eliminates any potential loops from the tree and ensures that the shortest path (in terms of hop count) is always used.

6.5 Class-of-Service (CoS) Support

The switch provides two transmit queues on each port, with a weighted fair queuing scheme. This function can be used to provide independent priorities for various types of data such as real-time video or voice, and best-effort data.

Priority assignment to a packet in this switch can be accomplished in any of the following ways:

- Priority can be explicitly assigned by end stations which have applications that require a higher priority than best-effort. This switch utilizes the IEEE 802.1p and 802.1Q tag structure to decide priority assignments for the received packets.
- A port may be manually configured as high priority. In this case, when any other port receives traffic from a high-priority port, that traffic is automatically placed in the high-priority output queue.

6.6 BOOTP/DHCP Relay

Dynamic Host Configuration Protocol (DHCP), described in RFC 1541, is an extension of the Bootstrap Protocol (BOOTP). DHCP allows hosts on a TCP/IP network to dynamically obtain basic configuration information. When a DHCP client starts, it broadcasts a DHCP Request packet, looking for DHCP servers. DHCP servers respond to this packet with a DHCP Response packet. The client then chooses a server to obtain TCP/IP configuration information, such as its own IP address.

Since DHCP uses a broadcast mechanism, a DHCP server and its client must physically reside on the same subnet. However, it is not practical to have one DHCP server on every subnet; in fact in many cases, DHCP/BOOTP clients and their associated DHCP/BOOTP server(s) do not reside on the same IP network or subnet. In such cases, a third-party agent is required to transfer BOOTP messages between clients and servers.

BOOTP/DHCP Relay, described in RFC 1542, enables a host to use a BOOTP or DHCP server to obtain basic TCP/IP configuration information, even if the servers do not reside on the local subnet. When an Switch BOOTP/DHCP Relay Agent receives a DHCP Request packet destined for a BOOTP/DHCP server, it inserts its own IP address into the DHCP Request packet so the server knows the subnet where the client is located. Then, depending on the configuration setup, the switch either:

- Forwards the packet to a specific server as defined in the switch's configuration using unicast routing, or
- Broadcasts the DHCP Request again to another directly attached IP subnet specified in the switch configuration for the receiving IP subnet.

When the DHCP server receives the DHCP request, it allocates a free IP address for the DHCP client from its scope in the DHCP client's subnet, and sends a DHCP Response back to the DHCP Relay Agent. The DHCP Relay Agent then broadcasts this DHCP Response packet received from the DHCP server to the appropriate client.

6.7 Security Features

The switch provides security features that allow you to control management access and network access as described in the following sections.

6.7.1 *SNMP Community Strings*

Access to the switch using network management tools (HP OpenView) is controlled by SNMP community strings. This switch supports up to five community strings. A character string indicating the access rights of the management community must be provided whenever you send an SNMP message to the switch. Each community has either read-only or read/write access rights. A community that has read-only access can only use GET and GETNEXT commands to view the current configuration settings and status of the switch. While a community with read/write access can GET and GETNEXT commands, as well as the SET command to configure the switch.

6.7.2 *User Name and Passwords*

This switch can also be accessed via a direct connection to the console port, or through a network connection using Telnet or a Web browser. When managing the switch by any of these means, a user name and password is required to enter the system. There are two sets of user names and passwords. One set has administrator rights, which allows you to view or modify system parameters. The other set has read-only access, which allows you to view the status of the system, but not to modify it.

6.7.3 *MAC Address Filters*

If you discover that some nodes are sending abnormal or malicious data that could adversely affect the network or cause security problems, you can set their MAC addresses to be filtered by the switch. Any packets with a source or destination address listed in the MAC address filter will then be dropped by the switch upon entry.

6.7.4 *IP Address Filters*

IP addresses can also set to be filtered by the switch. IP packets with a source or destination address listed in the IP address filter will be dropped by the switch upon entry.

6.8 SNMP Management Software

SNMP (Simple Network Management Protocol) is a communication protocol designed specifically for managing devices or other elements on a network. Network equipment commonly managed with SNMP includes hubs, switches, bridges, routers and host computers. SNMP is typically used to configure these devices for proper operation in a network environment, as well as monitor them to evaluate performance and detect potential problems.

6.9 Remote Monitoring (RMON)

Remote Monitoring provides a cost-effective way to monitor large networks by placing embedded or external probes on distributed network equipment (hubs, switches or routers). Network management software can access the embedded probes in network products to perform traffic analysis, troubleshoot network problems, evaluate historical trends, or implement proactive management policies. RMON has already become a valuable tool for network managers faced with a quickly changing network landscape that contains dozens or hundreds of separate segments. RMON is the only way to retain control of the network and analyze applications running at multi-megabit speeds. It provides the tools you need to implement either reactive or proactive policies that can keep your network running based on real-time access to key statistical information.

This switch provides support for mini-RMON which contains the four key groups required for basic remote monitoring. These groups include:

Statistics: Includes all the tools needed to monitor your network for common errors and overall traffic rates. Information is provided on bandwidth utilization, peak utilization, packet types, errors and collisions, as well as the distribution of packet sizes.

History: Can be used to create a record of network utilization, packet types, errors and collisions. You need a historical record of activity to be able to track down intermittent problems. Historical data can also be used to establish normal baseline activity, which may reveal problems associated with high traffic levels, broadcast storms, or other unusual events.

Historical information can also be used to predict network growth and plan for expansion before your network becomes too overloaded.

Alarms: Can be set to test data over any specified time interval, and can monitor absolute or changing values (such as a statistical counter reaching a specific value, or a statistic changing by a certain amount over the set interval). Alarms can be set to respond to either rising or falling thresholds.

Events: Defines the action to take when an alarm is triggered. The response to an alarm can include recording the alarm in the Log Table or sending a message to a trap manager. Note that the Alarm and Event Groups are used together to record important events or immediately respond to critical network problems.

Appendix A Troubleshooting

A.1 Troubleshooting Chart

Troubleshooting Chart	
Symptom	Action
Cannot connect using Telnet, Web browser, or SNMP software	<ul style="list-style-type: none">• Be sure you have configured the agent with a valid IP address, subnet mask and default gateway (Layer 2 of WGS3-2620).• Check that you have a valid network connection to the switch and that the port you are using has not been disabled.• Check network cabling between the management station and the switch.• If you cannot connect using Telnet, there may already be four active sessions. Try connecting again at a later time.
Can't access the on-board configuration program via a serial port connection	<ul style="list-style-type: none">• Be sure you have set the terminal emulator program to VT100 compatible, 8 data bits, 1 stop bit, no parity, and 19200 bps.• Check that the null-modem serial cable conforms to the pin-out connections provided in Appendix B.
Forgot or lost the password	<ul style="list-style-type: none">• Reinstall the switch firmware as described on the next page. Otherwise, contact Technical Support for help.

A.2 Upgrading Firmware via the Serial Port

You can upgrade system firmware by connecting your computer to the serial port on the switch, and using a console interface package that supports the XModem protocol. (See “3.2 Required Connections”)

1. Restart the system by using the Restart System command; or by pulling out the power cord to reset the power, waiting five seconds, and plugging it back in.

```
POST Version          V2.55.A03 8/18/2000

----- Power-On Self Test (POST)-----
Int. Loopback Testing SCC2 UART Channel ... PASS
Testing the System SDRAM ..... PASS
Int. Loopback Testing _____ UART Channel ... PASS
Int. Loopback Testing _____ UART Channel ... PASS
CPU Self Test ..... PASS
Test Accessing Agent's Config EEPROM ..... PASS
FlashROM CheckSum Test ..... PASS

!!! If you want to download image file, Please press < D > to download :
!!!      Download Runtime image, press < r >
!!!      Download Diagnostic image, press < d >
!!!      Clear the system parameter block < c >r
Please input the Baud Rate as following :
Press 1: Baud Rate = 9600
Press 2: Baud Rate = 19200
Press 3: Baud Rate = 38400
Press 4: Baud Rate = 57600
Press 5: Baud Rate = 115200
Select a number and then press <ENTER> !!! 5
Please change local console BaudRate to exact rate and press <ENTER>!!!
```

2. When the system initialization screen appears as shown above, press “D” to download system firmware, and then indicate the code type (<r> Runtime image or <d> Diagnostic image).

3. Change your baud rate to the selected value, and press Enter to enable download. From the terminal emulation program, select the file you want to download, set the protocol to XModem, and then initialize downloading.

NOTE:

1. If you use Windows HyperTerminal, disconnect  , set the baud rate, and reconnect  .

2. The download file should be a binary file or an image file; otherwise the agent will not accept it.

4. After the file has been downloaded, the console screen will display information similar to that shown below. Press Enter to download to permanent memory, change the baudrate back to 19200, press Enter to start decompressing the new firmware, and then press Enter to open the Logon screen.

```
XModem Download to 0x00400020: ... SUCCESS !
(P)ermanent or (T)emporary Download: [P]
Update RunTime Image at 0x03040000 ... .. SUCCESS !
Change to original Baud Rate and Press <ENTER> to Run Application !!!
Decompress now..... !!!
run-time code starting now. !!! Starting System...
MAINBOARD OCTOPUS0 RAMBIST TEST..... PASS!
MAINBOARD OCTOPUS1 RAMBIST TEST..... PASS!
MAINBOARD OCTOPUS2 RAMBIST TEST..... PASS!
MAINBOARD OCTOPUS3 RAMBIST TEST..... PASS!
MAINBOARD DOLPHIN RAMBIST TEST..... PASS!
MAINBOARD STARFISH RAMBIST TEST..... PASS!

Press <Enter> to start UI
```

For details on managing the switch, refer to “Chapter 4. Console Interface” for information on the out-of-band console interface, or “Chapter 5. Web Interface” for information on the Web interface.

Appendix B Pin Assignments

Console Port Pin Assignments

The DB-9 serial port on the switch's rear panel is used to connect to the switch for out-of-band console configuration. The on-board menu-driven configuration program can be accessed from a terminal, a PC running a terminal emulation program, or from a remote location via a modem connection. The pin assignments used to connect to the serial port are provided in the following tables.

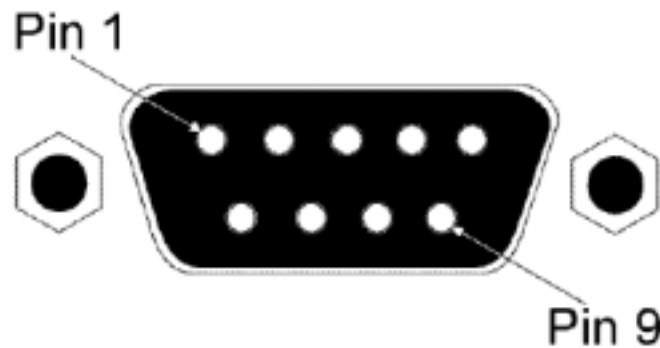

Figure B-1. DB-9 Console Port Pin Numbers

DB-9 Port Pin Assignments

EIA Circuit	CCITT Signal	Description	Switch's DB9 DTE Pin #	PC DB9 DTE Pin #	Modem DB25 DCE Pin #	Signal Direction DTE-DCE
CF	109	DCD (Data Carrier Detected)	1	1	8	<-----
BB	104	RxD (Received Data)	3	2	3	<-----
BA	1033	TxD (Transmitted Data)	2	3	2	----->
CD	108	DTR (Data Terminal Ready)	6	4	20	----->
AB	102	SG (Signal Ground)	5	5	7	-----
CC	107	DSR (Data Set Ready)	4	6	6	<-----
CA	105	RTS (Request-to-Send)	8	7	4	----->
CB	106	CTS (Clear-to-Send)	7	8	5	<-----
CE	125	RI (Ring Indicator)	9	9	22	<-----

Console Port to 9-Pin COM Port on PC

Switch's 9-Pin Serial Port	CCITT Signal	PC's 9-Pin COM Port
1 DCD	----- DCD -----	1
2 TXD	----- RXD ----->	2

3 RXD	<----- TXD ----->	3
4 DSR	----- DTR -----	4
5 SGND	----- SGND -----	5
6 DTR	----- DSR ----->	6
7 CTS -	<----- RTS -----	7
8 RTS	----- CTS ----->	8
9 RI	----- RI -----	9

Console Port to 25-Pin DCE Port on Modem

Switch' s 9-Pin Serial Port	CCITT Signal	Modem's 25-Pin DCE Port
1	<----- DCD ----->	8
3	<----- RXD ----->	3
2	----- TXD ----->	2
6	----- DTR ----->	20
5	----- SGND -----	7
4	<----- DSR ----->	6
8	----- RTS ----->	4
7	<----- CTS ----->	5
9	<----- RI ----->	22

GLOSSARY

Bandwidth Utilization

The percentage of packets received over time as compared to overall bandwidth.

BOOTP

Boot protocol used to load the operating system for devices connected to the network.

Distance Vector Multicast Routing Protocol (DVMRP)

A distance-vector-style routing protocol used for routing multicast datagrams through the Internet. DVMRP combines many of the features of RIP with Reverse Path Broadcasting (RPB).

GARP VLAN Registration Protocol (GVRP)

Defines a way for switches to exchange VLAN information in order to register necessary VLAN members on ports along the Spanning Tree so that VLANs defined in each switch can work automatically over a Spanning Tree network.

Generic Attribute Registration Protocol (GARP)

GARP is a protocol that can be used by endstations and switches to register and propagate multicast group membership information in a switched environment such that multicast data frames are propagated only to those parts of a switched LAN containing registered endstations. Formerly called Group Address Registration Protocol.

Group Attribute Registration Protocol

See Generic Attribute Registration Protocol.

Generic Multicast Registration Protocol (GMRP)

GMRP allows network devices to register end-stations with multicast groups. GMRP requires that any participating network devices or end-stations comply with the IEEE 802.1p standard.

ICMP Router Discovery

ICMP Router Discovery message is an alternative router discovery method that uses a pair of ICMP messages on multicast links. It eliminates the need to manually configure router addresses and is independent of any specific routing protocol.

Internet Control Message Protocol (ICMP)

Commonly used to send echo messages (i.e., Ping) for monitoring purposes.

IEEE 802.1D

Specifies a general method for the operation of MAC bridges, including the Spanning Tree Protocol.

IEEE 802.1Q

VLAN Tagging—Defines Ethernet frame tags which carry VLAN information. It allows switches to assign end-stations to different virtual LANs, and defines a standard way for VLANs to communicate across switched networks.

IEEE 802.3ac

Defines frame extensions for VLAN tagging.

Internet Group Management Protocol (IGMP)

A protocol through which hosts can register with their local router for multicast services. If there is more than one multicast router on a given subnetwork, one of the routers is elected “querier” and assumes the responsibility of keeping track of group membership.

IGMP Snooping

Listening to IGMP Query and IGMP Report packets transferred between IP Multicast Routers and IP Multicast host groups to learn IP Multicast group members.

In-Band Management

Management of the network from a station attached directly to the network.

IP Multicast Filtering

A process whereby this switch can pass multicast traffic along to participating hosts.

Layer 2

Data Link layer in the ISO 7-Layer Data Communications Protocol. This is directly related to the hardware interface for network devices and passes traffic based on MAC addresses.

Layer 3

Network layer in the ISO 7-Layer Data Communications Protocol. This layer handles the routing functions for data moving from one open system to another.

Link Aggregation

See Port Trunk.

Management Information Base (MIB)

An acronym for Management Information Base. It is a set of database objects that contains information about a specific device.

Multicast Switching

A process whereby the switch filters incoming multicast frames for services no attached host has registered for, or forwards them to all ports contained within the designated multicast VLAN group.

Open Shortest Path First (OSPF)

OSPF is a link state routing protocol that functions better over a larger network such as the Internet, as opposed to distance vector routing protocols such as RIP. It includes features such as unlimited hop count, authentication of routing updates, and Variable Length Subnet Masks (VLSM).

Out-of-Band Management

Management of the network from a station not attached to the network.

Port Mirroring

A method whereby data on a target port is mirrored to a monitor port for troubleshooting with a logic analyzer or RMON probe. This allows data on the target port to be studied unobtrusively.

Port Trunk

Defines a network link aggregation and trunking method which specifies how to create a single high-speed logical link that combines several lower-speed physical links.

Remote Monitoring (RMON)

RMON provides comprehensive network monitoring capabilities. It eliminates the polling required in standard SNMP, and can set alarms on a variety of traffic conditions, including specific error types.

Routing Information Protocol (RIP)

The RIP protocol attempts to find the shortest route to another device by minimizing the distance vector, or hop count, which serves as a rough estimate of transmission cost. RIP-2 is a compatible upgrade to RIP. It adds useful capabilities for subnet routing, authentication, and multicast transmissions.

Simple Network Management Protocol (SNMP)

The application protocol offering network management services in the Internet suite of protocols.

Serial Line Internet Protocol (SLIP)

Serial Line Internet Protocol, a standard protocol for point-to-point connections using serial lines.

Spanning Tree Protocol (STP)

A technology that checks your network for any loops. A loop can often occur in complicated or back-up linked network systems. Spanning-tree detects and directs data along the shortest path, maximizing the performance and efficiency of the network.

Telnet

Defines a remote communication facility for interfacing to a terminal device over TCP/IP.

Trivial File Transfer Protocol (TFTP)

A TCP/IP protocol commonly used for software downloads.

Virtual LAN (VLAN)

A Virtual LAN is a collection of network nodes that share the same collision domain regardless of their physical location or connection point in the network. A VLAN serves as a logical workgroup with no physical barriers, allowing users to share information and resources as though located on the same LAN.

XModem

A protocol used to transfer files between devices. Data is grouped in 128-byte blocks and error-corrected.